

Biomet® OrthoPak® Non-invasive Bone Growth Stimulator System

Complete Manual
and Package Insert



Table Of Contents

System Contents	1
Important Safeguards	2
The Biomet® OrthoPak Non-invasive Bone Growth Stimulator System	3
• Description	3
• Electrical Requirements For Battery And Charger	3
System Components	3,4
Full Prescribing Information	5-6
• Indications For Use, Contraindications, Warnings, Precautions, Adverse Effects	5-6
Operating Instructions	6-9
• Recommended Usage	6
• Step 1: Battery Pack Charging	6,7
• Step 2: Preparing The System To Begin Treatment	8
• Step 3: Recharging The Battery Pack	9
Button Function	9
• Alarm On/Off Button	9
Directions For Use	9-13
LCD Symbols Description And Instructions	14
Treatment Completion	14
Patient Compliance Monitoring	14
Ordering Information	15
Equipment Classification	15
Symbol Description	15
Cleaning Instructions	16
Electromagnetic Compatibility	16-19
Patient Counseling Information	20
Storage And Handling	20
Disposal Instructions	20
Electrode Instructions For Use	21

System Contents

- Electrodes
- Charger Cradle
- Rechargeable Battery Packs (2)
- Electrode Cover Patches
- Controller
- Device Holster
- Lead Wires - 20" Lead Wire and 48" Lead Wire
- Patient Manual
- Complete Manual and Package Insert
- A/C Power Adapter
- Extremity Band
- Cast Windowing Kit



Important Safeguards



Read All Instructions Before Using

Save These Instructions

When using electrical products, basic safety precautions should always be followed:

ATTENTION: To reduce the risk of electric shock, fire or injury:

1. Do not use this product while bathing, showering or swimming.
2. Do not place or store this product where it can fall or be pulled into a tub or sink.
3. Do not immerse the stimulator, battery charger or battery pack in water or any liquid.
4. Do not reach for this product if it has fallen into water. Unplug from the wall outlet immediately.
5. Do not permit the battery charger to be connected to the stimulator when wet.
6. Do not touch the battery pack contacts when the battery charger is plugged into an outlet.
7. Never operate the battery charger if it has a damaged power cord, plug or if it is not working properly. Do not use if it has been dropped and damaged, or immersed into water. Contact Customer Service for return instructions.
8. Do not attempt to charge any other type of battery pack in the OrthoPak battery charger.
9. Keep all cords away from heated surfaces.
10. Never insert any foreign object into any opening of the system.
11. Do not expose the stimulator or the battery charger to prolonged heat or direct sunlight. (Normal operating temperature range is 5°C to 38°C [41°F to 100°F], normal storage/transport temperature is -15°C to 50°C [5°F to 122°F].)
12. Use this product only for its intended use as described in this manual.
13. The OrthoPak has no installation, periodic maintenance requirements or user serviceable parts. If any of the replacement parts are damaged they must be replaced by Customer Service in order to avoid a hazard.
14. Do not short circuit, overcharge, crush, mutilate, nail penetrate, heat, reverse the + or - terminals or disassemble the battery pack. Do not allow metal objects to come into contact with the battery pack terminals. These and any other abuses of the battery pack may cause serious injury and/or burns. To ensure proper charging and safety, use only the charger supplied with your device. Keep battery pack dry. This battery pack must be disposed of properly. Disposal information can be obtained by contacting the Rechargeable Battery Recycling Corporation (RBRC) at 1-800-822-8837 in the US.

NOTE: Call Customer Service at 1-800-526-2579 with questions or concerns.

Biomet® OrthoPak® Non-invasive Bone Growth Stimulator System

Caution: Federal Law (U.S.A.) restricts this device to sale by or on the order of a physician. Rx Only.



Figure 1

 **This device is not intended for re-sale or re-distribution. Single patient use only.**

Description

The Biomet® OrthoPak® Bone Growth Stimulator promotes (Figure 1) healing by inducing a low electrical current at the fracture nonunion site. The therapeutic signal generates a low energy electrical field by passing a specific current between the electrodes.

Electrical Requirements Battery And Charger

Input: 100-240 VAC 50/60 Hz 6 W

Output: 12 VDC 500mA

For use with the OrthoPak rechargeable battery pack only (PN 1067720).

Battery rating: 3.7 VDC \geq 800 mAh

Do not use the rechargeable battery pack supplied with this system in any other device. Use of the OrthoPak battery pack in any other device may cause damage or malfunction to the battery pack and/or devices.

System Components

Stimulator

The OrthoPak operates on a rechargeable battery pack, which allows for ambulatory use. It includes an audible and visible self-checking alarm mechanism to alert the patient if it is not functioning properly.

The OrthoPak is designed to store the patient's daily therapeutic treatment which may be downloaded and read with the patient compliance software (See Patients Compliance Monitoring Page 14). Patients are encouraged to bring the stimulator to each follow-up visit with the prescribing physician to review how they are using their stimulator.

System Components

Battery And Battery Charger

The OrthoPak includes two rechargeable battery packs. Upon receipt, it is recommended that the second battery pack be immediately placed into the charger and fully charged. In the meantime, the first battery pack may be used to begin the patient's treatment.

Note: The first battery pack may not provide a 24-hour treatment initially. It is recommended that the patient keep one battery pack in the battery charger to insure that it is fully charged and ready, and the other inserted into the stimulator. This will ensure continuous treatment as prescribed by the prescribing physician.

The battery charger is designed to recharge the OrthoPak battery packs only. Two LED (light emitting diode) lights monitor and indicate the operational status of the battery charger, a green A/C power indicator light and an orange charging status indicator light. The following table lists and describes the indications of the indicator lights:

Status	A/C Power Indicator Light	Charging Status Indicator Light on Cradle
No battery pack inserted (idle) on A/C powered battery charger	Solid green	Off
Battery pack in charging state	Solid green	Solid orange
Fully charged battery pack	Solid green	Solid green
A/C power deficiency	Off	Off
Error	Solid green	Off

Following Are Possible Error Conditions And Possible Resolutions

Error Conditions (flashes orange)	Possible Resolutions
Battery pack not properly connected to the charger	Remove and re-install the battery pack to ensure complete connection to the charger
Battery temperature is too low or high	Normal operating temperature is 5°C to 38°C [41°F to 100°F]
Battery voltage is too low	Contact Customer Service for a new battery pack

Electrodes

A supply of electrodes is included with every assembly. The patient should replace electrodes every 1 to 7 days. Patients can order additional electrodes by calling 1-800-526-2579 and then dialing extension 6000.

Electrode Covers

The electrode covers are water resistant and are intended to enhance electrode security to the skin, if needed, or for showering with the electrodes attached, if desired.

Device Holster

The device holster is designed to securely hold the OrthoPak in place. It has a clip on the back which allows the patient to wear the device on their waistband or belt.

Lead Wires

Two different length lead wires are included with the OrthoPak. The patient should choose the lead wire that best accommodates their needs for where they would like to wear the control unit.

Full Prescribing Information

Indications For Use

The OrthoPak is indicated for the treatment of an established nonunion acquired secondary to trauma, excluding vertebrae and all flat bones, where the width of the nonunion defect is less than one-half the width of the bone to be treated. A nonunion is considered to be established when the fracture site shows no visible progressive signs of healing.

The original approval was based on a PMA Study, which included 69 patients with efficacy of 72.5%. An additional cohort of 21 recalcitrant patients with multiple prior procedures and unsuccessful electrical stimulation with different modality was added and yielded efficacy of 33.3%. Seventy-nine patients out of 90 treated had at least 4 years follow-up after the date of treatment termination for a follow-up rate of 88%. The follow-up results were 45 patients healed; four previously healed patients have died; three patients, who were "healing" at the end of treatment, were healed with additional treatment. Counting only the 45 unconditionally healed patients, the efficacy at 4 year follow-up was 50%. A subsequent survey of 295 patients conducted from March 1988 to September 1990 by an independent agency, yielded an efficacy of 73.2%.

Contraindication:

The use of this device is contraindicated if the individual has synovial pseudarthrosis.

Warnings:

- Utilization of this stimulator allows full weight bearing on the casted extremity unless gross motion (greater than 5 degrees in any plane) at the nonunion site is present. In such a case, weight bearing is not advised and should not be permitted as this may compromise the effectiveness of the treatment. The safety and effectiveness of the use of the device on individuals lacking skeletal maturity has not been established.
- In the presence of a malignant nonunion, careful consideration on the use of this device must be undertaken on an individual basis, as treatment with this device is not yet intended to alter or affect the degree of malalignment.
- The amplitude of the treatment current must be between 5 and 10 milliamperes RMS. Treatment with this device is not recommended on patients whose electrical impedance of the tissue between the electrodes will not allow the device to operate within the prescribed 5 to 10 milliamperes range. The safety and effectiveness of the use of this device on individuals with nonunion secondary to, or in conjunction with, a pathological condition has not been established.
- Animal studies conducted to date indicate that the OrthoPak does not interfere with the normal intrinsic activity of the heart. However, the stimulator does interfere with the operation of certain pacemakers. The concomitant use of the device and a pacemaker must be assessed on an individual basis, prior to use (such as with an electrocardiogram).
- Animal studies conducted to date do not suggest any long term adverse effects from use of this device. However, long term effects in humans are unknown. Do not use this device beyond the prescribed treatment period. General tissue sensitivity at the skin/electrode site with unknown specific etiology may occur. This tissue sensitivity may be caused by the electrode gel, excess perspiration or a combination of both. Such a reaction generally resolves spontaneously following diagnosis and correction of the underlying cause.

Precautions:

Although laboratory teratological studies performed with this device demonstrate no adverse findings, the safety of this device used during pregnancy and nursing in humans has not been established. Compliance with the treatment schedule, daily battery change and proper maintenance of the device and the change of the electrodes are essential. The device will not perform properly and treatment may be unnecessarily prolonged if you fail to adhere to the care regimen. Components in this system are to be used only with approved parts. No attempt should be made to modify, repair or substitute parts or components for this device.

Adverse Effects

NOTE: With the exception of the following, no known adverse effects have resulted from the use of this device:

General tissue sensitivity at the skin/electrode site with unknown specific etiology may occur. This tissue sensitivity may be caused by the electrode gel, excess perspiration or a combination of both. Such a reaction generally may be resolved spontaneously following diagnosis and correction of the underlying cause.

Operating Instructions

Recommended Usage

The OrthoPak is designed to deliver 270 days of continuous therapeutic treatment for 24 hours per day. The recommended daily therapeutic treatment is continuous for 24 hours.

Prior to initial treatment, the battery pack must be fully charged. After 24-hours of continuous use, the battery pack requires charging. Each OrthoPak includes two rechargeable battery packs. Always have one battery pack installed in the stimulator and have one battery pack charging in the battery charger. Additional battery packs are available through Customer Service (See Page 2). Each day, preferably at the same time, you should change the battery pack following these instructions.

Step 1:

Battery Charging: Charging will take between two to three hours.

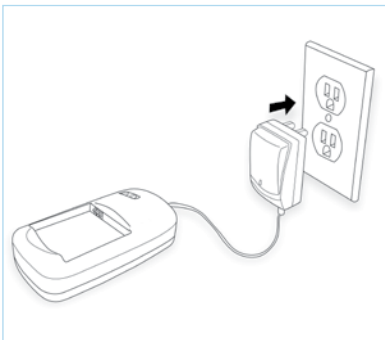

1. Plug the battery charger into a wall outlet. Attach charger and cradle.

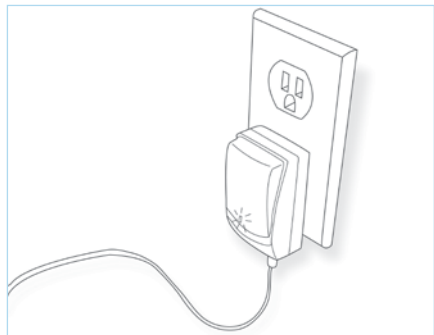

2. A solid green light on the A/C adapter will illuminate indicating power.

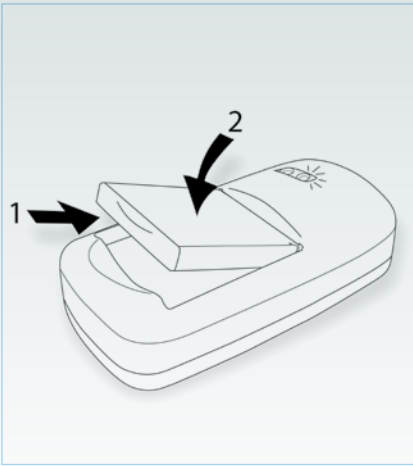

3. Following arrows, install the battery pack into the battery charger cradle as illustrated: (1) Lightly press down on battery pack to ensure contact (2) A solid orange light on the charger cradle will illuminate indicating battery is installed and charging properly.



4. If a battery pack is in the charger cradle and no light is illuminated, an error is indicated. See page 14 for possible error reasons and possible solutions.



5. When the battery pack is fully charged a solid green light should be on.



6. Remove the battery pack from the battery charger cradle (1, 2). The battery pack is now ready for connection into the stimulator. Remove the current battery pack from the stimulator and place that battery pack in the charger cradle for recharging.

Step 2:

Preparing The Stimulator To Begin Therapeutic Treatment

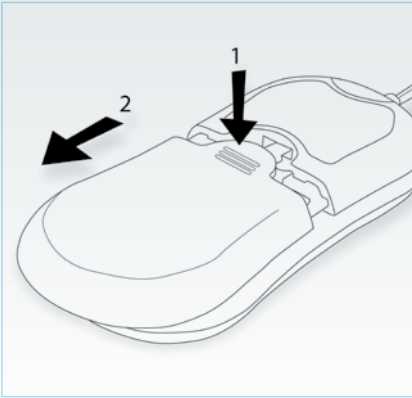

1. Depress the battery door latch (1) and slide down the battery door on the back of the stimulator (2) and remove the depleted battery pack.

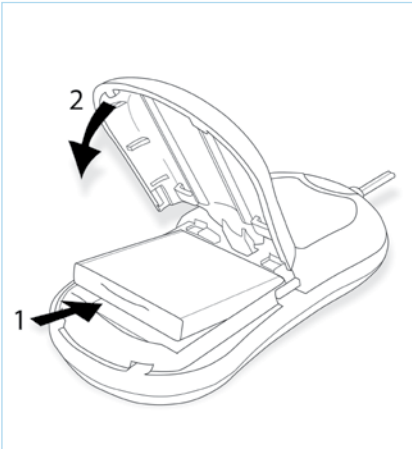

2. Following arrows, insert the charged battery pack into the OrthoPak by sliding it into the battery compartment (an LED light will blink, and sound a beep, indicating power) and closing the battery door (1, 2).

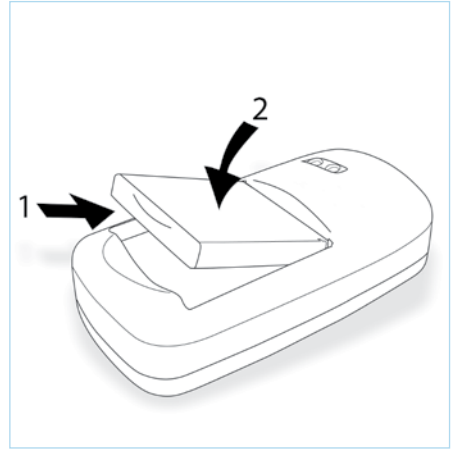

3. Insert the uncharged battery pack into the battery charger cradle by pushing it onto the charger cradle (1). Lightly press down on the battery pack to ensure contact (2).

Step 3:

Recharging The Battery Pack

NOTE: The battery pack cannot be overcharged. If the battery pack is in the battery charger cradle and the battery pack is already fully charged, the charger will terminate the recharging process early. This will be indicated by the solid green light on the charging cradle when charging is complete. Do not be concerned if the battery pack is inadvertently charged more than once or kept on the charger cradle for a long period of time.

When the OrthoPak needs a fully charged battery pack, the following will occur:

1. The OrthoPak LCD screen will indicate the symbol for the low battery (See LCD Symbol Descriptions and Instructions Page 14). With the audio alarm engaged, beeping will occur.
2. Only after the patient inserts a charged battery pack into the OrthoPak will it indicate a ✓ symbol.

Button Function

Alarm On/Off Button

The OrthoPak is activated as soon as a charged battery pack is inserted. The button located below the LCD display enables or disables the audible alarm. During an alarm condition, depressing the button quickly (0.5 seconds) will temporarily disable the audible alarm. Depressing the button for a longer period of time (3 seconds) will toggle the audible alarm between enabled and disabled. Patients should be advised to leave the audible alarm enabled as frequently as possible in order to assure the fully prescribed treatment. A speaker symbol will be indicated on the LCD display when the alarm is enabled.

Directions For Use

Patients should be instructed in the proper use and daily maintenance of the device. All instructions below are also presented in the Patient Manual, which is included with every OrthoPak.

Electrodes

The low profile hydrogel electrodes are mounted on a release liner (Figure 1).

Electrode Application

See instructions for use on Page 21 for electrode application. Connect the electrodes to the electrode lead wire.

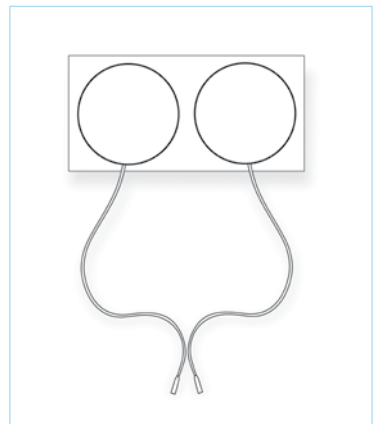

Figure 1

With use, the electrode gel area may dry out and the electrode may lose its contact with the skin. (This may cause the LED on the stimulator to blink intermittently, and cause an audible intermittent alarm sound). If this occurs, the electrode may be reapplied. If dry, moisten the entire gel area of the electrode with tap water. Reapply the electrode to the patient's skin. If necessary replace the electrodes.

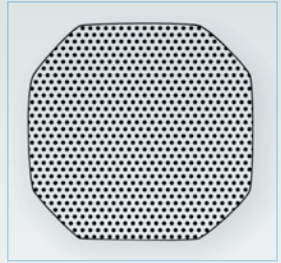

Figure 2

Electrode cover patches may be used to protect the electrodes during showering. (Figure 2)

NOTE: Patient must remove stimulator before showering. The protective covers are provided to prevent the necessity of completely removing the adhesive electrodes and then re-applying them following personal hygiene.

Selection of Electrode Sites

Following routine roentgenographic assessment, select the axis around the fracture nonunion for the placement of electrodes. Placement of the electrodes in the anteroposterior, mediolateral or any axis around the area of the fracture nonunion is at the discretion of the physician.

Electrodes should be placed so that they transmit minimal stimulation through scar tissue, are convenient to access for replacement and are least likely to be disturbed during normal daily activities.

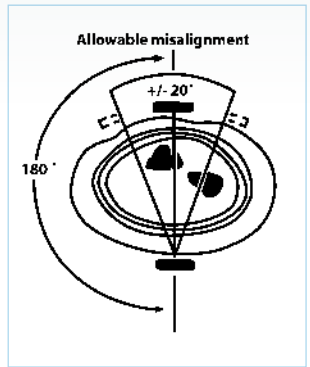

Figure 3

The placement of the electrodes on either side of the fracture nonunion site should be positioned 180° to each other. A tolerance of plus or minus 20° of misalignment is allowable. (Figure 3)

In the plane of the long axis of the bone, the tolerance misalignment is equal to the 1-3/8 inch diameter of an electrode. (Figure 4)

NOTE: It is advisable to remove body hair at the electrode sites. The hair should be clipped with scissors or an electric shaver. DO NOT USE A BLADE, IT MAY IRRITATE THE SKIN.

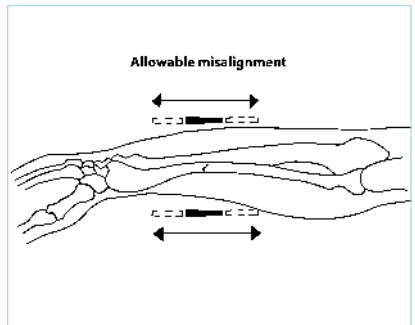

Figure 4

Foam Spacers

Foam spacers are to be used only in casted applications. Depending on the thickness of the cast, place a spacer over each of the electrodes in the window openings. The spacer should fill the gap in the cast, but should not create excessive pressure on the electrodes when wrapped. When the cast is very thin, spacers are not needed. (Figure 5)

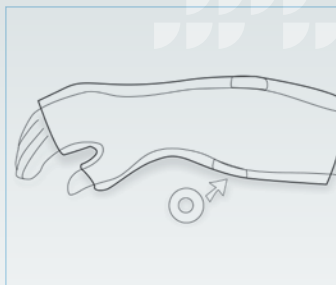

Figure 5

To Begin Treatment

Connect the two electrode wires into the lead wire. Insert the lead wire plug into the jack at the top of the stimulator, shown in Figure 6.

If the stimulator is functioning properly, the stimulator display will indicate ✓ (Figure 7). This means that the electrodes are properly applied, the battery is functioning, and the device is delivering therapeutic current. If the device is not functioning properly, an audible alarm and LED light will appear with an alarm indication (See LCD Symbol Description and Instructions Page 14). If the audible alarm and alarm condition indicates low battery, the battery voltage is too low. Insert a freshly charged battery pack and recharge the used battery pack. See LCD Symbol Descriptions and Instructions on Page 14 for other alarm conditions.

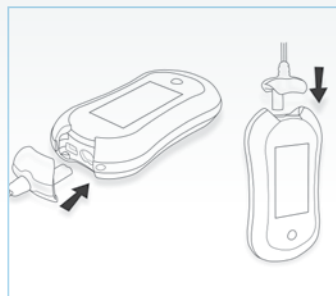

Figure 6

Lead Wires

Lead wires are used to connect the electrode pads to the OrthoPak. Lead wires are provided in two lengths: 20, and 48 inches. Additional lengths are available from Customer Service.



Figure 7

Electrode Cover Patches

Electrode cover patches are available to be used for non-casted applications by patients who are experiencing difficulty keeping the electrode pads in good contact with the skin.

When the electrode cover patch is properly applied over the electrode pad, the patient will be able to shower without removing the electrode pad. (Figure 8)



Figure 8

Immobilization

Techniques may vary with each patient, requiring the use of a cast, brace, or splint. The patient is given a number of options for wearing/carrying the OrthoPak, depending on the type of immobilizer used. In the event of a casted application, it will be necessary to access electrode skin sites through prepared windows. The step-by-step procedure for preparing the cast is as follows:

Preparing The Cast

Identify the fracture site based upon review of previous x-rays or physician selection. Mark the cast at desired level.

Apply the adhesive (paper) templates to both sides of the cast at the selected fracture site. Templates are labeled, "TEMPLATE FOR WINDOWING CAST. CUT ALONG OUTSIDE EDGE WITH CAST CUTTING TOOL." (Figure 9)

Utilizing standard cast cutting tool, cut out window along edges of the template guide. This will assure proper sizing of cast window. (Figure 10)

Trim cast padding and stocking material to provide direct skin access for the electrodes. Following directions on electrode package, place electrodes on to skin sites, adding gentle pressure. (Figure 11)

Once extremity band is placed (centered) on the cast between the windows, attach hemmed end of Velcro® like wrap onto extremity band.



Figure 9



Figure 10



Figure 11

To attach the OrthoPak to the extremity band, simply place the stimulator into the holster and clip onto the extremity band.

Remote Mount

Use the enclosed holster and/or extremity band to directly attach the stimulator to a brace, splint or cast. (Figure 15)



Figure 15

Connection of Electrodes

If the stimulator is worn at the waist (Figure 16) select the 48-inch electrode lead wire.

If the stimulator is to be placed on the extremity band, select the 20-inch lead wire. (Figure 17)

Connect electrode pads to the lead wire.

Gently press electrodes onto skin.
See instructions Page 21.

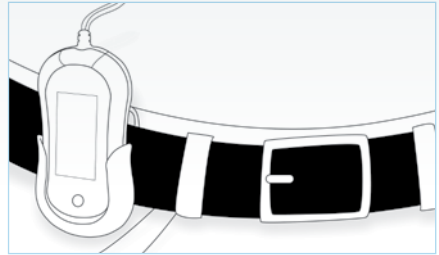

Figure 16

Stimulator Mounting Options

Patients have several options for mounting the stimulator at the waist (Figure 17).

1. The stimulator can be kept in a shirt or pants pocket.
2. The stimulator can also be placed in the holster. The holster has a clip on the back of it which allows the patient to wear it on their waistband or belt. The holster also allows the patient to clip the stimulator to the extremity band. The extremity band can be placed in a location convenient to the patient and close to the fracture site.

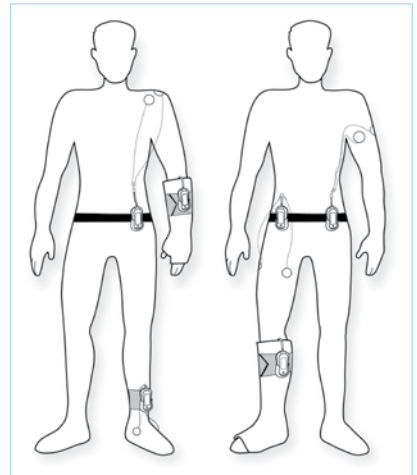









Figure 17

Deciding the best mounting option for the stimulator is based on patient preference and/or advice from a physician.

LCD Symbol Description and Instructions

The alarm defaults to audible alarm. Press the button below the display on the front of the stimulator to silence the alarm. After silenced, the light will continue to flash and the display will indicate the alarm condition.

Symbol	Condition	Instructions
	Treating	Continue use.
	Audible alarm	If beeping, depress the button briefly to silence the alarm. Depress the button approximately 3 seconds to engage or disengage the audible alarm.
	Low battery charge	Insert a charged battery pack.
	Disconnection	Confirm that each electrode is properly applied on the skin. See Page 21 for instructions. Confirm that the lead wire is attached properly. Replace the lead wire if necessary.
	System error	Error in the stimulator – Contact Customer Service for assistance.
	Stimulator is connected to a PC	Stimulator will not treat until USB cable is disconnected
	End of operation/ Treatment Completion	Contact Customer Service

Treatment Completion

Treatment should not be suspended until fusion occurs or until such time as the determination is made by the prescribing physician that no progression to fusion is occurring. The device is programmed to deliver 270 days of continuous therapeutic treatment and automatically discontinues operation.

Patient Compliance Monitoring

The OrthoPak contains embedded software which allows the display of patient specific history data including usage and therapeutic treatment times. This data may be downloaded to a personal computer for viewing, storage and/or print out via the use of Compliance Data Download Software. Please call your local representative to obtain more information.

Ordering Information

To order supplies, contact Customer Service. See page 2, "Important Safeguards", for contact information.

The following information is necessary to expedite any inquiry:

- Patient name
- Physician name
- Address to send replacement items (patient home, MD office, etc.)

Equipment Classification

- Stimulator - Internally powered by rechargeable batteries
- Charger - Class II, Type B
- Ordinary Equipment without protection against ingress of water
- Equipment not suitable for use in presence of flammable anesthetic mixture with air or oxygen or nitrous oxide
- Mode of operation - Continuous

Symbol Description



Attention see instructions



WEEE



Alternating Current



Single Patient Use



Direct Current

Rx only

Prescription Only



Type B



Warning: The concomitant use of the stimulator and a pacemaker or cardioverter must be assessed by a cardiologist on an individual basis with an Electrocardiogram (EKG).



Storage/Transport temperature limits



Class II



Non Sterile



Caution: The safety of this device used during pregnancy and nursing in humans has not been established.



Manufacturer

Cleaning Instructions

Use a damp cloth for cleaning any part of the OrthoPak. Do not use cleaning products or detergents.

Electromagnetic Compatibility

- A. The use of accessories, lead wires or replacement parts other than those supplied by ZimVie may result in increased emissions or decreased immunity of the equipment or system.
- B. This equipment should not be used adjacent to or stacked upon other equipment.
- C. Portable and mobile RF communications equipment may adversely affect the operation of Medical Electrical Equipment.
- D. In the event this equipment interferes with the operation of other equipment, or experiences interference from other equipment, to continue treatment, move the OrthoPak away from the source of the interference as indicated in Table 4.

Table 1

Guidance and manufacturer’s declaration - electromagnetic emissions		
<p>The OrthoPak is intended for use in the electromagnetic environment specified below. The customer or the user of the OrthoPak should assure that it is used in such an environment.</p>		
Emissions test	Compliance	Electromagnetic environment - guidance
RF emissions CISPR 11	Group 1	The OrthoPak uses RF energy only for its internal function. Therefore, its RF emissions are very low and not likely to cause any interference in nearby electronic equipment.
RF emissions CISPR 11	Class B	The OrthoPak is suitable for use in all establishments, including domestic establishments and those directly connected to the public low-voltage power supply network that supplies buildings used for domestic purposes.
Harmonic emissions IEC 61000-3-2	Not applicable	
Voltage fluctuations/ flicker emissions IEC 61000-3-3	Not applicable	

Table 2

Guidance and manufacturers declaration - electromagnetic immunity

The OrthoPak is intended for use in the electromagnetic environment specified below.
The customer or the user of the OrthoPak System should ensure that it is used in such an environment.

Immunity test	IEC 60601 test level	Compliance level	Electromagnetic environment - guidance
Electrostatic discharge (ESD) IEC 610004-2	± 6 kV contact ± 8 kV air	Group 1	Floors should be wood, concrete or ceramic tile. If floors are covered with synthetic material, the relative humidity should be at least 30 %.
Electrical fast transient/burst IEC 61000-4-4	Not applicable	Class B	
Surge IEC 61000-4-5	Not applicable	Not applicable	
Voltage dips, short interruptions and voltage variations on power supply input lines IEC 61000-4-11	Not applicable	Not applicable	
Power frequency (50/60 Hz) magnetic field IEC 61000-4-8	Not applicable	Not applicable	

Table 3

Guidance and manufacturers declaration - electromagnetic immunity

The OrthoPak is intended for use in the electromagnetic environment specified below.
The customer or the user of the OrthoPak should assure that it is used in such an environment.

Immunity test	IEC 60601 test level	Compliance level	Electromagnetic environment - guidance
Conducted RF IEC 61000-4-6	Not applicable	Not applicable	
Radiated RF IEC 61000-4-3	3 V/m 80 MHz to 2.5 GHz	1 V/m	<p>Portable and mobile RF communications equipment should be used no closer to any part of the OrthoPak, including cables, than the recommended separation distance calculated from the equation applicable to the frequency of the transmitter.</p> <p>Recommended separation distance</p> <p>$d = 3.5 \sqrt{P}$ 80 MHz to 800 MHz</p> <p>$d = 7 \sqrt{P}$ 800 MHz to 2.5 GHz</p> <p>Where P is the maximum power output rating of the transmitter in watts (W) according to the transmitter manufacturer and d is the recommended separation distance in meters (m).</p> <p>Field strengths from fixed RF transmitters, as determined by an electromagnetic site survey,^a should be less than the compliance level in each frequency range.^b</p> <p>Interference may occur in the vicinity of equipment marked with the following symbol:</p> 

NOTE 1. At 80 MHz and 800 MHz, the higher frequency applies.

NOTE 2. These guidelines may not apply in all situations. Electromagnetic propagation is affected by absorption and reflection from structures, objects, and people.

^a Field strengths from fixed transmitters, such as base stations for radio (cellular/cordless) telephones and land mobile radios, amateur radio, AM and FM radio broadcast and TV broadcast cannot be predicted theoretically with accuracy. To assess the electromagnetic environment due to fixed RF transmitters, an electromagnetic site survey should be considered. If the measured field strength in the location in which the OrthoPak is used exceeds the applicable RF compliance level, the OrthoPak device should be observed to verify normal operation. If abnormal performance is observed, additional measures may be necessary, such as reorienting or relocating the OrthoPak.

^b Over the frequency range 150 kHz to 80 MHz, field strengths should be less than 1 V/m.

Table 4

Recommended separation distances between portable and mobile RF communications equipment and the OrthoPak

The OrthoPak is intended for use in an electromagnetic environment in which radiated RF disturbances are controlled. The customer or the user of the OrthoPak can help prevent electromagnetic interference by maintaining a minimum distance between portable and mobile communications equipment (transmitters) and the OrthoPak as recommended below, according to the maximum power output of the communications equipment.

Rated maximum output power of transmitter	Separation distance (meters) according to frequency of transmitter		
W	150 kHz to 80 MHz $d = 3.5 \sqrt{P}$	80 MHz to 800 MHz $d = 3.5 \sqrt{P}$	800 MHz to 2.5 GHz $d = 7 \sqrt{P}$
0.01	.35	.35	.7
0.1	1.1	1.1	2.21
1	3.5	3.5	7
10	11.06	11.06	22.13
100	35	35	70

For transmitters rated at a maximum output power not listed above, the recommended separation distance (d) in meters (m) can be estimated using the equation applicable to the frequency of the transmitter, where P is the maximum output power rating of the transmitter in watts (W) according to the transmitter manufacturer.

NOTE 1. At 80 MHz and 800 MHz, the separation distance for the higher frequency applies.

NOTE 2. These guidelines may not apply in all situations. Electromagnetic propagation is affected by absorption and reflection from structures, objects, and people.

Patient Counseling Information

The patient should be thoroughly instructed on how to properly use and care for the OrthoPak, and receive the Patient Manual, which provides detailed instructions. A summary of the key points in the patient labeling is provided below.

- Compliance** The patient should be instructed that compliance with device use and care is critical to ensure the proper function of the device and effective treatment.
- Battery** The patient should be instructed to insert a charged battery pack in the stimulator every 24 hours.
- Electrodes** The patient should be instructed to replace the electrodes when needed and to clean the electrode sites thoroughly with soap and water prior to applying the electrodes.
- Skin Irritation** The patient should be instructed to examine the skin for irritation when replacing the electrodes. If irritation is present, the patient should be instructed to relocate the electrodes adjacent to the original sites. The patient should be evaluated periodically to assess the skin for sensitivity.
- Alarms** See LCD Symbol Descriptions and Instructions (page 14). The patient should be instructed to keep the audible alarm system engaged as often as practical and to reset the alarm system if it has been toggled to the disengaged position as soon as practical.
- Bathing** The patient should be instructed to disconnect the stimulator during bathing, showering or swimming. It should be reconnected as soon as practical following these activities. The patient should also be instructed to remove or cover the electrodes with the electrode cover patches during showering.

Storage and Handling

The OrthoPak should be stored in a cool and dry place. The device components should be handled with care. Damage may occur if the device is inappropriately handled or abused.

Disposal Instructions

When treatment has concluded as determined by the prescribing physician, ZimVie requests that the patient disposes the OrthoPak according to local statutes and regulations.

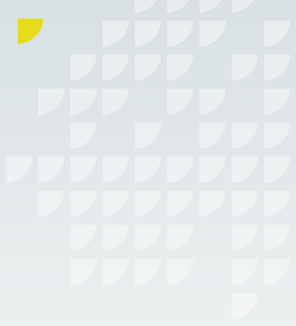

Electrode Instructions for Use

Do not open outer packet until ready to use.

1. Tear open packet.
2. Remove electrode from clear plastic backing liner.
3. Wet finger with tap water and moisten entire gel area.
4. Place electrode on skin.
5. Connect electrode to electrode lead.

Renewal

1. With continuous use, electrodes may dry out.
2. To renew, wet finger with tap water and moisten entire gel area.
3. Reapply electrode to skin.

Store in a cool place

Notes: _____

Options

The industry's most comprehensive options:

- PEMF, CC and DC
- Anatomy specific coils
- Wear-time choice

Evidence

- Backed by proven science
- Multiple scientific papers
- The proof is in the patient

Experience

Recognized as an industry pioneer with EBI lineage, ZimVie has helped over one million people

OrthoPak Bone Growth Stimulator

Complete Manual and Package Insert

To learn more about this product, contact your local Sales Representative today.

PN # 1067799-00 Rev.G



For more information, visit [ZimVie.com](https://www.zimvie.com)

ZimVie

1 Gatehall Drive,
Suite 303
Parsippany, NJ 07054
1-800-526-2579



Legal Manufacturer

Mfd. by: EBI Patient Care, Inc.
A ZimVie Company
484 Calle E
Guaynabo, PR 00969 USA



Unless otherwise indicated, all trademarks herein are the property of ZimVie Inc. and its subsidiaries, including EBI, LLC, Inc. (collectively, "ZimVie"). Unless otherwise indicated, all products herein are manufactured, marketed, and distributed by ZimVie. For additional product information, please refer to the individual product labeling or instructions for use. Federal Law (U.S.A.) restricts this device to sale by or on the order of a physician. Rx Only. Single Patient Use Only. Distribution to any other recipient is prohibited. This material may not be copied or reprinted without the express written consent of ZimVie.
PN#1067799-00 Rev. G ZVI186 REV B 02/24. ©2024 ZimVie Inc. All rights reserved.