

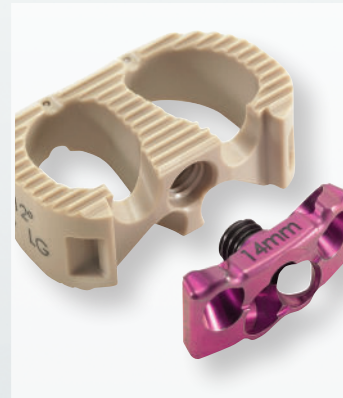

# Durango<sup>®</sup>

ALIF System

Surgical Technique Guide

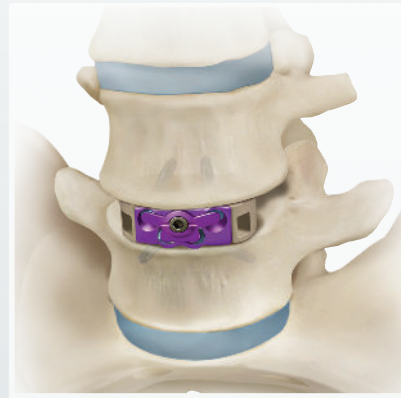
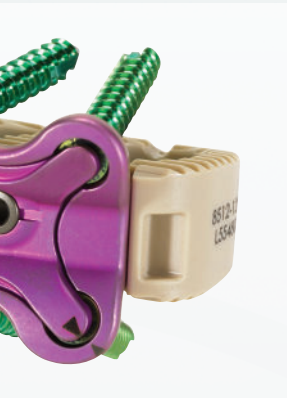

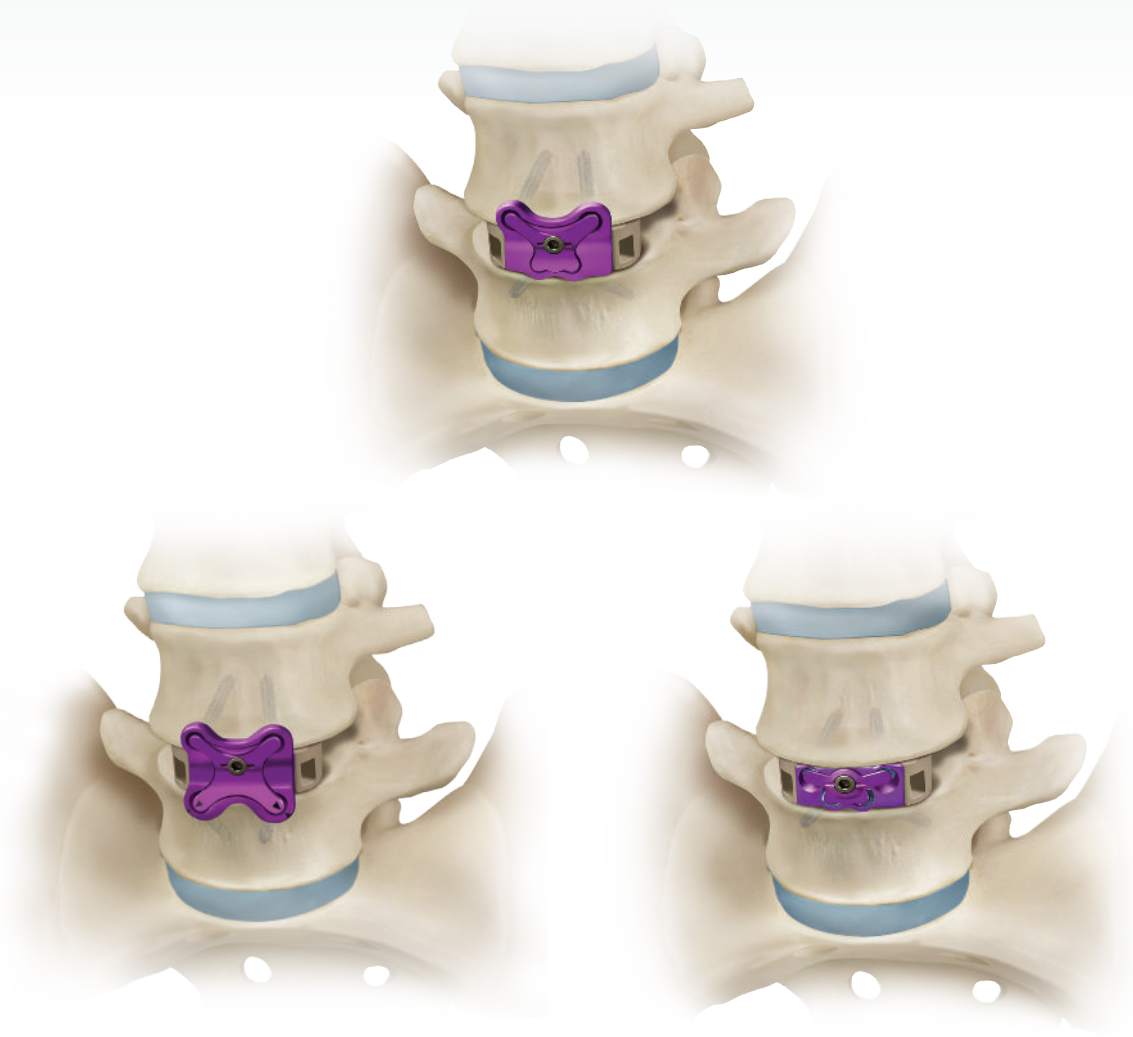

Unique flexibility to address a variety of stability requirements and anatomic demands.

## Table of Contents

Features of the Durango System	4
Preparation and Access	5
Selection and Assembly	6
Insertion and Screw Preparation	8
Drill Guide Technique	8
Freehand Technique	13
Removing the Implant	19
Final Implant Position and Closure	20
Durango Screw Length Diagrams	21
Instruments	23
Implants	26
Inspection Considerations	28
Important Information on the Durango ALIF System	29

ZimVie Spine does not practice medicine. This technique was developed in conjunction with health care professionals. This document is intended for surgeons and is not intended for laypersons. Each surgeon should exercise his or her own independent judgment in the diagnosis and treatment of an individual patient, and this information does not purport to replace the comprehensive training surgeons have received. As with all surgical procedures, the technique used in each case will depend on the surgeon's medical judgment as the best treatment for each patient. Results will vary based on health, weight, activity and other variables. Not all patients are candidates for this product and/or procedure.

## Features of the Durango System

The Durango ALIF System is a modular, integrated plate and interbody system for ALIF interbody fusion. The plate component is available in three configurations with different screw positions and angles to tailor the implant to the patient's anatomy and fixation demand. All screws are lag screws which draw the plate onto the vertebral bodies. Screw back-out is prevented with a single-step locking plate which quickly and securely locks into the plate.

Other features of the Durango system include two footprint options with a full range of heights for a precise anatomical fit, exceptionally large graft windows for a maximum fusion area and multiple technique options with intuitive instrumentation to seamlessly address a variety of clinical requirements. All interbody spacers are made from PEEK-OPTIMA® polymer from Invibio, Ltd.



### Zero-Plate

The Zero-Plate construct sits entirely within the interbody space to avoid contact with the great vessels. The screws are oriented at a 30° angle, relative to the interbody space, to make the procedure easier to accomplish while providing excellent purchase into the endplates of the vertebral bodies.

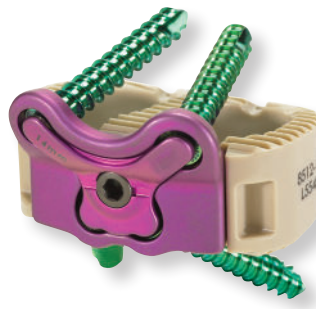

### Half-Plate

The Half-Plate construct incorporates two low-angle 15° screws, relative to the interbody space, which are positioned to engage the anterior cortex of the vertebral bodies and offer additional options to deal with challenging anatomy. For example, at L5-S1, where the interbody space is tilted relative to the body, the Half-Plate screws can be prepared and inserted using only straight instruments, which are easier to use than angled instruments. The Half-Plate also offers the ability to move instruments away from the vessels, especially at the bifurcation of the great vessels, helping to minimize the risk of vascular injury.



### Full-Plate

The Full-Plate construct utilizes four low-angle trajectory screws which engage the anterior cortex of the vertebral body, and most closely approximates a standard anterior lumbar plate system, while offering the convenience of a single construct for efficient implantation.

## Preparation and Access

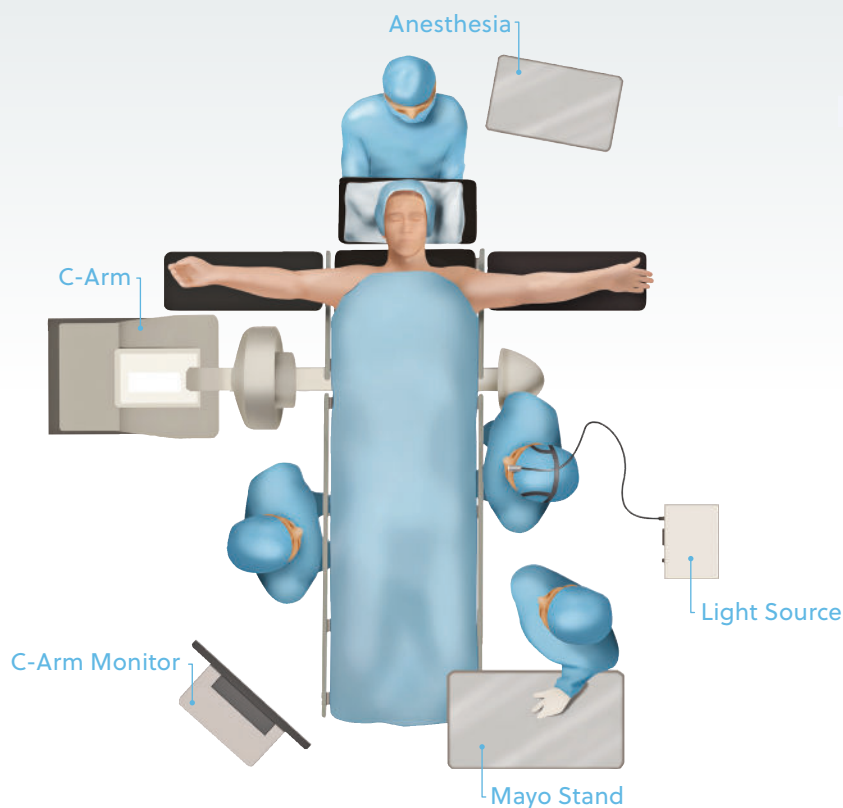

**Figure 1:**  
Surgical exposure and site preparation

- Review and inspect all instrumentation and implants prior to sterilization (refer to page 28 for additional inspection considerations).
- Replace or add any necessary components for the planned surgery.
- Surgeon must be fully experienced with the required spinal fusion techniques.
- Read the Instructions for Use (IFU) for a product description and a list of warnings, cautions, contraindications and risks.

### STEP 1

- Position and drape the patient in the usual fashion (**Figure 1**).
- Expose the affected levels via a standard incision and tissue dissection.
- Perform any necessary bone and tissue removal.
- Prepare vertebral endplates via the use of a combination of curettes, rasps, osteotomes, disc shavers or rongeurs to remove disc material and cartilage.

## Selection and Assembly of the Durango Implant

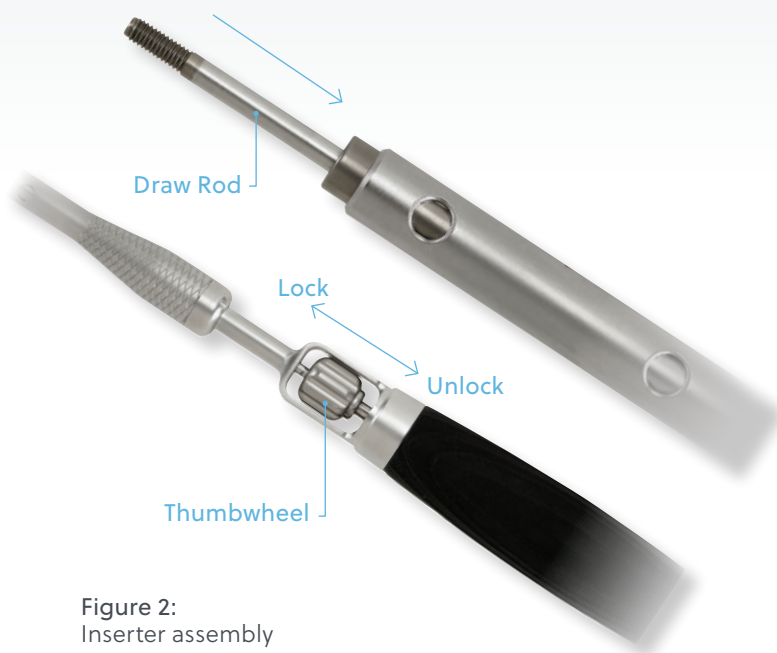

Figure 2:  
Inserter assembly



Figure 3:  
Trial assembly

### STEP 2

After preparing the intervertebral disc space, the trials are inserted to determine the size of the desired implant.

- Assemble the inserter handle by inserting the inserter handle draw rod through the center of the inserter (**Figure 2**).
- Secure by retracting the quick-connect thumbwheel of the inserter handle, fully inserting the draw rod, and then releasing the quick-connect thumbwheel.
- Assemble the trial onto the inserter handle by pulling back on the inserter sleeve. Ensure the trial is connected by pulling on the trial after releasing the sleeve (**Figure 3**).
- Insert the trials into the disc space to determine the size of the desired implant, starting with the smallest footprint and height, and progressing to larger and taller sizes as needed.

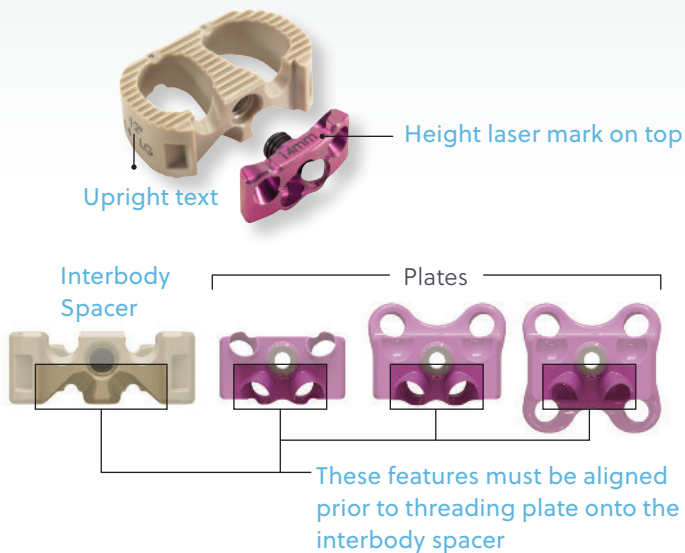

Figure 4:  
Implant assembly

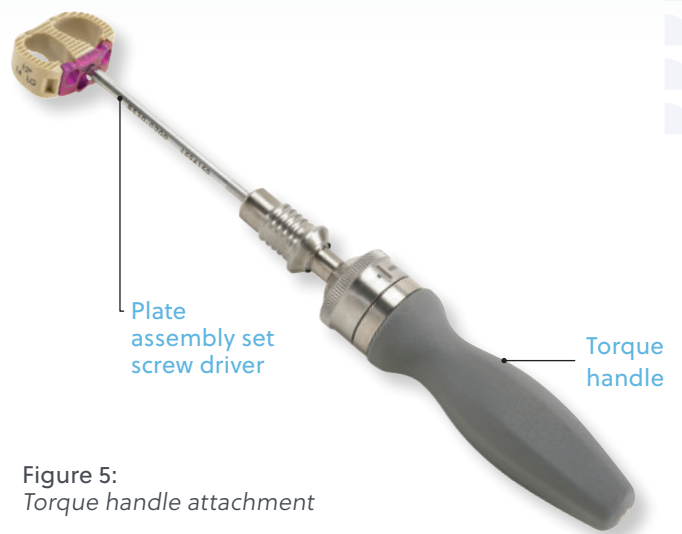

Figure 5:  
Torque handle attachment

### STEP 3

- Select the appropriate interbody spacer (footprint and height) and the plate type (Zero-Plate, Half-Plate or Full-Plate) of the same height.
- At the back table, align the plate and interbody spacer such that the set screw on the plate is positioned straight into the PEEK-OPTIMA spacer prior to threading it in (**Figure 4**).

**Note:** The plate will only attach to the interbody spacer in one orientation. Match the protrusions on the back side of the plate to the grooves in the interbody spacer prior to threading in the set screw. The text on the spacer should be upright while the height laser mark on the plate should be facing up.

- Attach the ratcheting torque handle to the plate assembly driver and tighten to the limit of the torque handle (12 in-lb [1.355 Nm]). (**Figure 5**)

**Note:** It may be easier to start the thread assembly utilizing the set screw driver without the torque handle.

**Note:** It is recommended to pack the central graft cavity of the assembled implant with autogenous bone graft material prior to implantation.



## Insertion and Screw Preparation



Figure 6:  
Drill guide A assembly

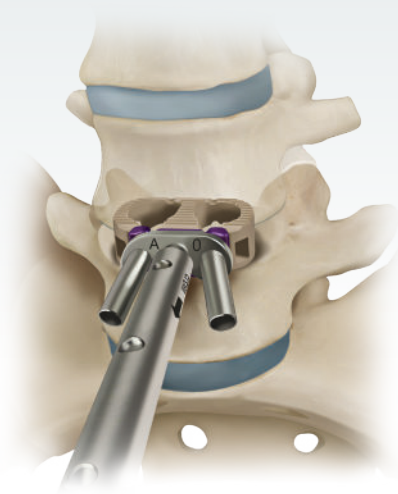

Figure 7:  
Drill guides A & B assembly

### Method I: Drill Guides Technique

There are two methods for inserting the implant and preparing and inserting the screws.

Method I: Drill Guides Technique uses double-barreled fixed drill guides to insert the implant into the intervertebral disc space, and to prepare and insert the screws (pages 8–12).

Method II: Freehand Technique uses a tamp-style inserter to insert the implant and freehand instruments to prepare and insert the screws (pages 13–16).

#### STEP 4

Drill guide A is used to insert the implant and the first two screws.

- Assemble the appropriate drill guide A plate (Zero-Plate, Half-Plate, Full-Plate) onto the inserter handle by pulling back on the inserter sleeve.
- Load the assembled implant onto the drill guide by inserting the tip of the draw rod into the plate and turning the thumbwheel clockwise (**Figure 6**).

#### STEP 5

Insert the assembled implant into the disc space. Radiographically confirm the position and placement of the implant (**Figure 7**).

**Note:** The edge of the radiographic markers are approximately 1.2mm from the posterior edge of the implant (see page 27).



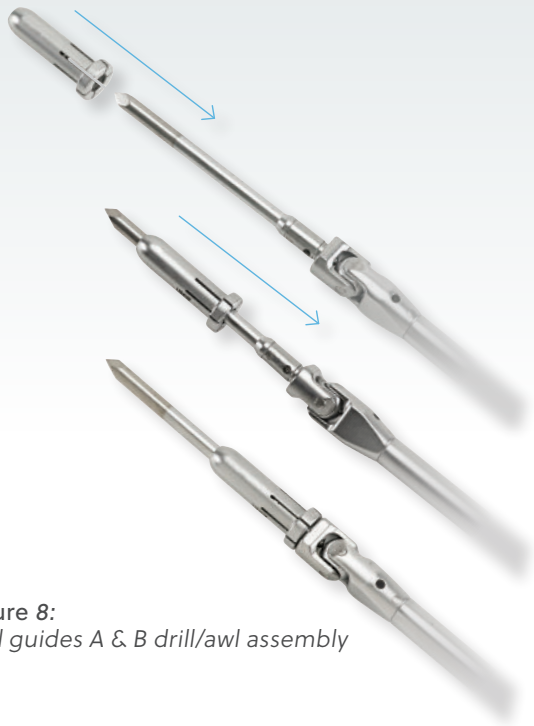

Figure 8:  
Drill guides A & B drill/awl assembly

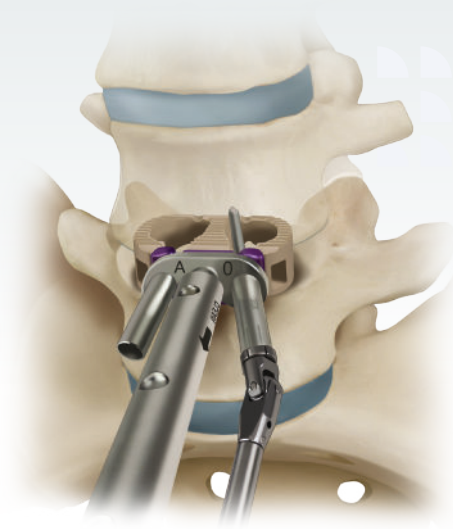

Figure 9:  
Drill guides a drill/awl insertion

## STEP 6

- Select either the u-joint drill, u-joint awl, straight drill, or straight awl, and assemble to the ratcheting straight handle or ratcheting T-handle.
- For the u-joint drill or u-joint awl, insert the drill guide adapter onto the tip of the instrument (**Figure 8**).

## STEP 7

- Sequentially insert the drill or awl into both barrels of drill guide A until the stop is reached. This provides 18mm of penetration (**Figure 9**).

## Method I: Drill Guides Technique (continued)

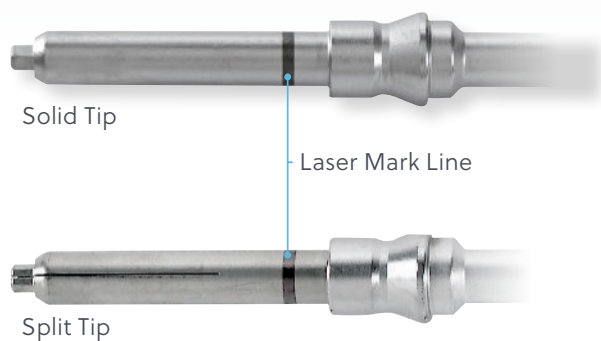

Figure 10:  
Drill guide A screw driver assembly

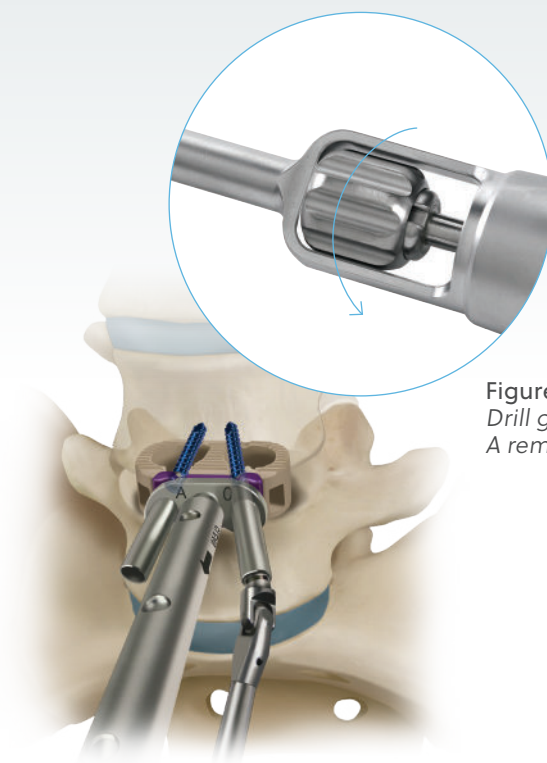

Figure 11:  
Drill guide A screw insertion

### STEP 8

- Load the appropriate length and type of screw onto the u-joint driver split tip or straight driver split tip, which is assembled to the ratcheting straight handle or ratcheting T-handle. A diagram of the screw lengths is provided on page 21-22.
- Straight screw drivers may be used with optional tissue protection by assembling a straight driver sleeve onto the screw driver prior to assembling the handle.

**Note:** Split tip drivers are self-retaining and are recommended for most applications. Solid tip drivers (u-joint driver solid tip or straight driver solid tip) are recommended if additional torque is desired while inserting the bone screw (**Figure 10**).

### STEP 9

- Insert the screw through the drill guide A. A laser mark line (**Figure 11**) indicates approximately when the screw driver has reached the full depth, but the final screw depth should be determined by the tactile bone purchase.
- Remove drill guide A by turning the inserter handle thumbwheel counterclockwise (**Figure 12**).

## The Second Set of Screws Are Prepared and Inserted Using Fixed Drill Guide B

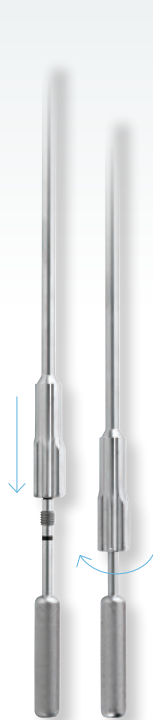

Figure 13a:  
Drill guides B  
screw insertion



Figure 13b

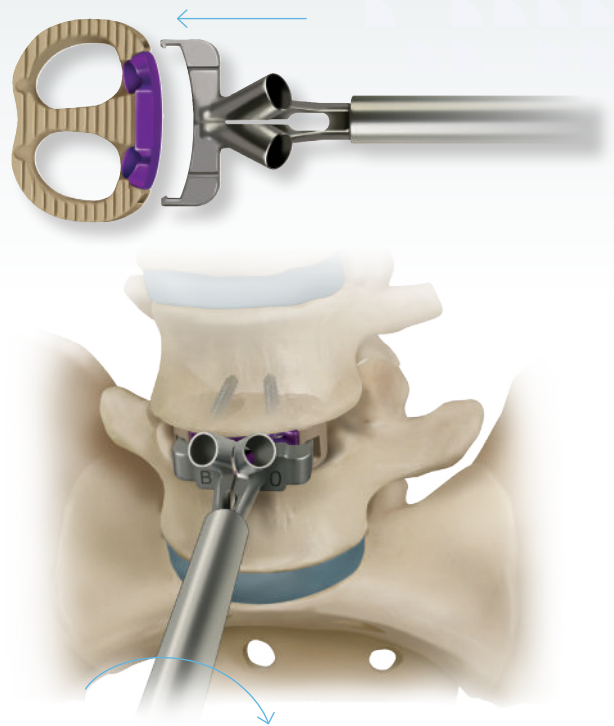

Figure 14:  
Load drill guide B onto implant

### STEP 10

- Assemble the drill guide B handle by threading the guide B handle sleeve over the guide B handle shaft all the way past the threads, until the sleeve can be retracted toward the handle (**Figure 13a**).
- Assemble the fixed drill guide B plate (Zero-Plate, Half-Plate, Full-Plate) onto the drill guide B handle by pulling back on the handle sleeve, inserting the drill guide and releasing (**Figure 13b**).
- Load the drill guide B onto the implant by aligning with the slots on the interbody spacer, and secure by turning the outer sleeve clockwise.
- Load the drill guide B onto the implant by aligning with the slots on the interbody spacer, and secure by turning the outer sleeve clockwise (**Figure 14**).

## Method I: Drill Guides Technique *(continued)*

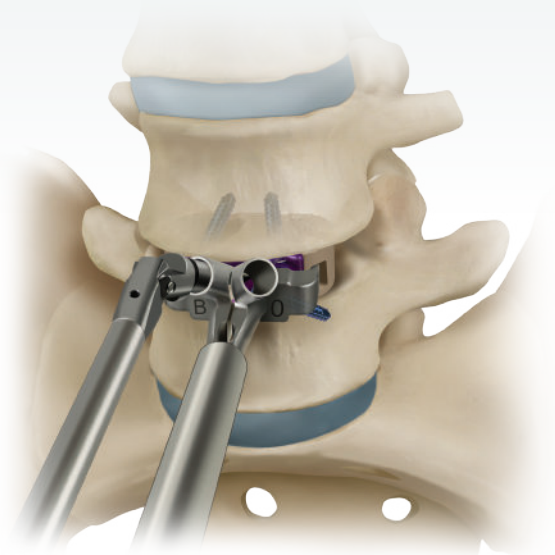

Figure 15:  
*Preparation of two screw holes*

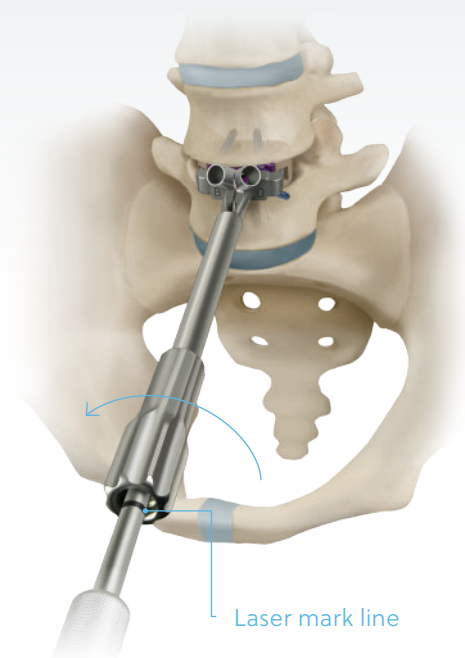

Figure 16:  
*Remove drill guide B*

### STEP 10 (continued)

- Prepare the remaining two screw holes through drill guide B using the drill or awl and insert the screws as described on page 10 (**Figure 15**).
- Remove drill guide B by turning the sleeve counterclockwise until the outer sleeve reaches the laser mark line (**Figure 16**).

## Insertion and Screw Preparation Method II: Freehand Instruments

(continued from page 7 after step 3)



Figure 17:  
Freehand inserter assembly

### STEP 4

- Assemble the appropriate freehand inserter tip (Zero-Plate) or universal inserter tip (Half-Plate or Full-Plate) onto the inserter handle by pulling back on the inserter sleeve, inserting the inserter tip and releasing.
- Load the assembled implant onto the inserter by inserting the tip of the draw rod into the plate and turning the thumbwheel clockwise (**Figure 17**).

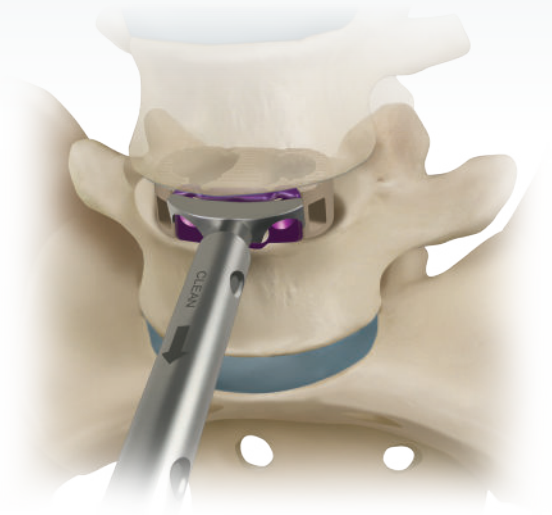

Figure 18:  
Implant insertion

### STEP 5

- Insert the assembled implant into the disc space (**Figure 18**). Radiographically confirm the position and placement of the implant.

**Note:** The edge of the radiographic markers are approximately 1.2 mm from the posterior edge of the implant (see page 27).

## Method II: Freehand Instruments (continued)



**Figure 19a:**  
Drill/awl assembly

**Figure 19b**

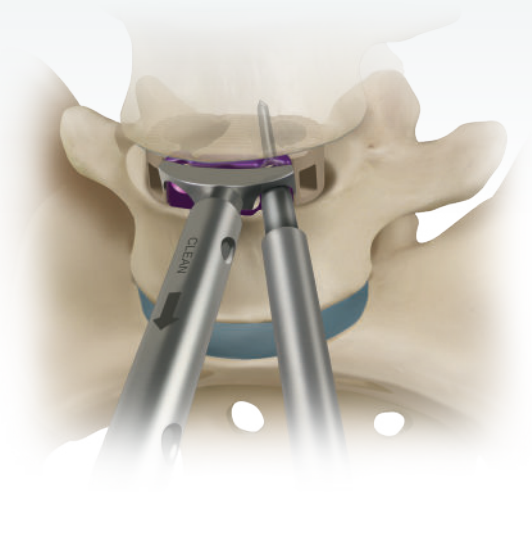

**Figure 20:**  
Drill /awl insertion: first two screws

### STEP 6

- Select the fixed angle guide to place the screw in the nominal trajectory or variable angle guide to aim the screw in an alternate trajectory. Fixed angle screws must be prepared using fixed angle guides. Variable angle screws may be prepared using either fixed angle guides or variable angle guides, which allow for an additional 8° of angulation in any direction.
- For preparation using straight instruments, select the straight sleeve fixed or the straight sleeve variable, and insert the straight drill or straight awl which is assembled to the ratcheting straight handle or ratcheting T-handle (**Figure 19a**).
- To remove the sleeve after use, pull the sleeve away from the handle to disengage it from the spring.
- For preparation using angled instruments, insert the u-joint drill or u-joint awl into the u-joint sleeve, and thread the retractable tip fixed or retractable tip variable onto the end of the sleeve (**Figure 19b**).

### STEP 7

- Insert the tip of the instrument into the screw pockets on the plate that are accessible, and insert the drill or awl into the bone until the stop is reached. This provides 18mm of penetration (**Figure 20**).

**Note:** For variable angle insertion of 25- or 30-mm screws, be sure to angle the drill or awl to avoid colliding the screw tips.



**Figure 21:**  
Screw driver assembly

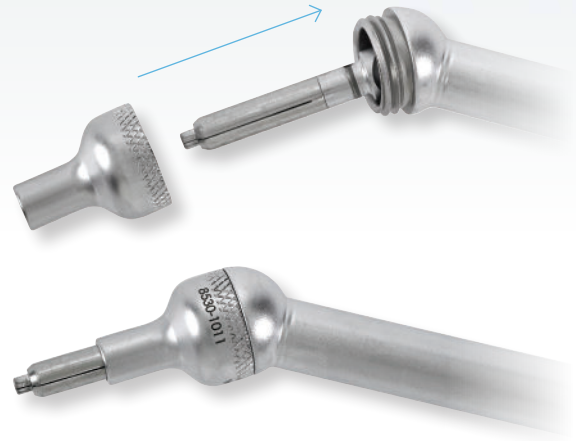

**Figure 22:**  
Screw insertion using angled instruments

## STEP 8

- For screw insertion using straight instruments, assemble the straight driver split tip onto the ratcheting straight handle or ratcheting T-handle, with or without the optional straight driver sleeve. The optional retractable straight driver tip, which covers the screw during freehand screw insertion, may be attached to the tip of the screw driver (**Figure 21**).
- For screw insertion using angled instruments, insert the u-joint driver split tip into the u-joint driver sleeve, thread the u-joint driver tip onto the end of the sleeve, and assemble on to the ratcheting straight handle or ratcheting T-handle (**Figure 22**).
- Load the appropriate length and type of screw (see page 27) onto the screw driver. A diagram of the screw lengths is provided on page 21-22.

**Note:** Fixed angle screws can only be used when the bone is prepared using fixed angle guides.

**Note:** Split tip drivers are self-retaining and are recommended for most applications. Solid tip drivers (u-joint driver solid tip or straight driver solid tip) are recommended if additional torque is desired while inserting the screw.



## Method II: Freehand Instruments (continued)

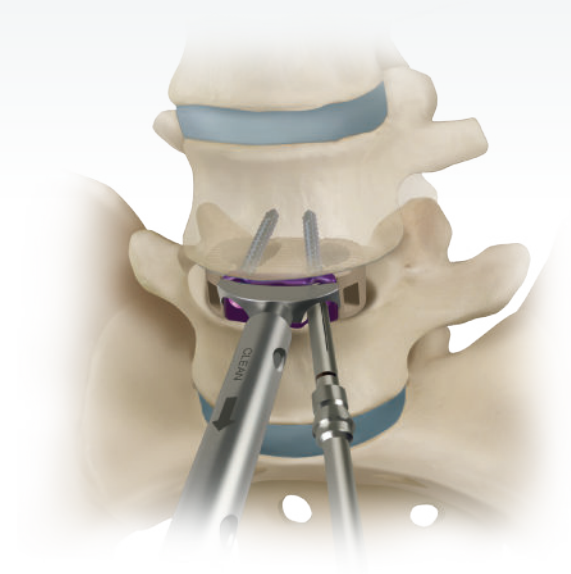

**Figure 23:**  
*Screw insertion: first two screws*

### STEP 9

- Insert the screw into the prepared screw hole (**Figure 23**).

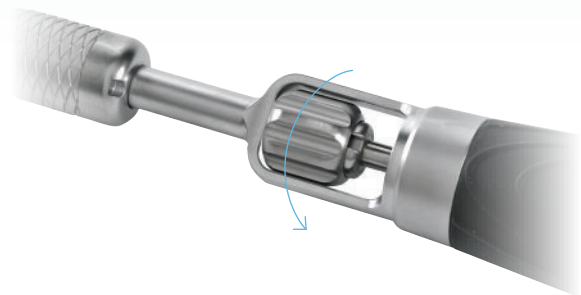

**Figure 24:**  
*Inserter removal*

### STEP 10

- Remove the inserter tip by turning the inserter handle thumbwheel counterclockwise (**Figure 24**).
- Repeat screw preparation and insertion for the remaining two screws.

## Optional Insertion Using the Distractor Inserter



**Figure 25a:**  
Prepare the distractor/  
insertor and set the  
countersink depth

**Figure 25b**

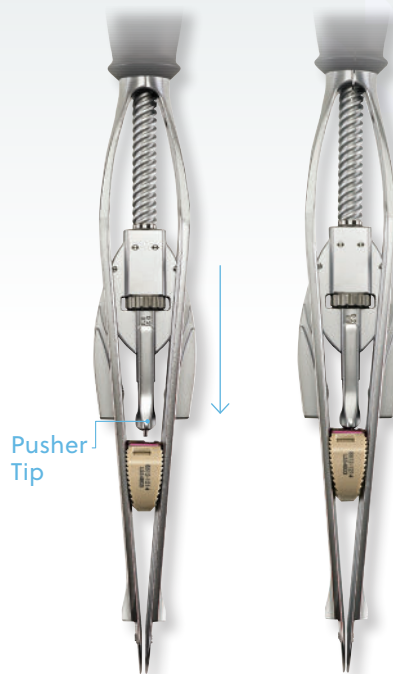

**Figure 26:**  
Load the implant into the distractor/insertor

An optional method for inserting Zero-Plate implants into the intervertebral disc space is to use the distractor/insertor to advance the implant into the disc space without impaction. Once the implant is inserted, the screws must be prepared and inserted using either Method I: Drill Guide Technique (pages 8-12) or Method II: Freehand Technique (pages 13-16).

**Note:** Half-Plate and Full-Plate assemblies are not to be inserted using the distractor/insertor.

- Prior to loading the implant, prepare the distractor/insertor by pressing the thread release button, and pulling back on the T-handle (**Figure 25a**).
- Set the countersink depth (0 to 8mm) by rotating the dial on the head block (**Figure 25b**).
- Load the implant into the blades of the distractor/insertor, and advance until the blades are about to separate. Advance the head block by pushing forward or rotating the T-handle until the pusher tip engages into the set screw of the implant (**Figure 26**).

## Optional Insertion Using the Distractor Inserter (continued)

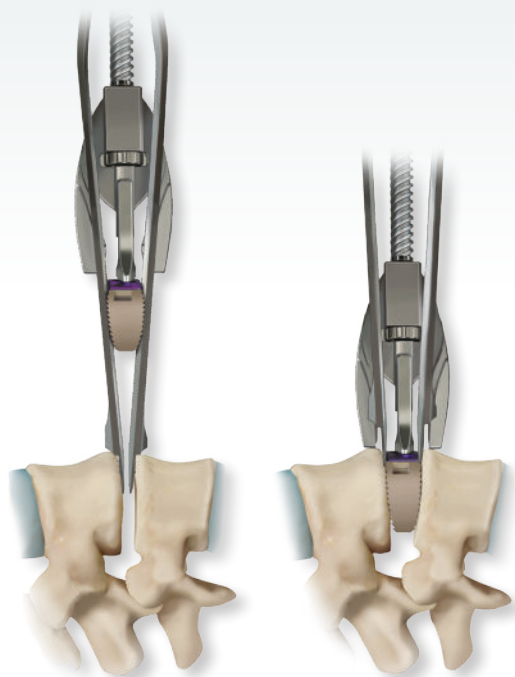

**Figure 27a:**  
*Insertion and removal  
of distractor/inserter*

**Figure 27b**

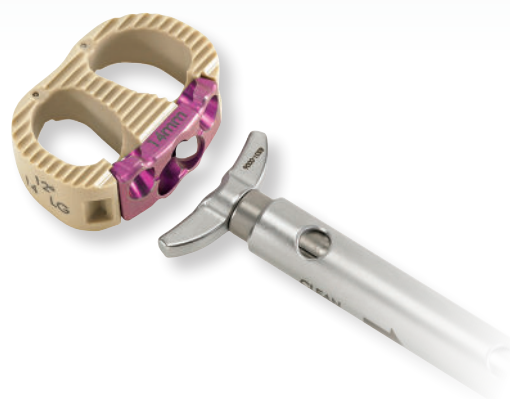
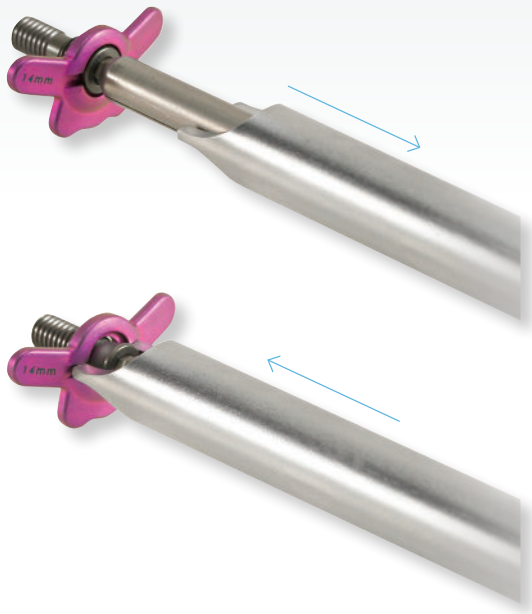

**Figure 28:**  
*Fine-tuning of the implant position*

### STEP 10 (Continued)

- Insert the tip of the distractor/inserter into the disc space, and insert the implant by rotating the T-handle clockwise while applying downward pressure on the handle (**Figure 27a**).
- To remove the distractor/inserter, continue to rotate the T-handle clockwise until the blades are ejected from the disc space (**Figure 27b**).
- Optional fine-tuning of the implant position can be achieved using the universal inserter tip assembled to the inserter handle with the draw rod removed (**Figure 28**).

## Inserting the Cover Plate



**Figure 29:**  
*Inserting the cover plate*

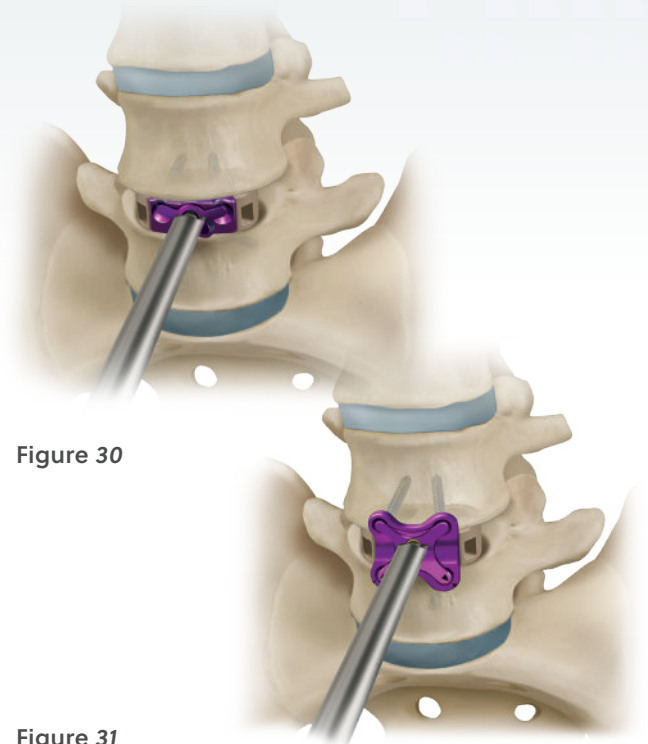

**Figure 30**

**Figure 31**

### STEP 11

For all plate configurations, a single cover plate is used to secure all screws from backing out.

- Select the cover plate that corresponds to the implanted plate (Zero-Plate, Half-Plate or Full-Plate).
- Load the cover plate onto the cover plate driver assembled on the ratcheting torque handle by pulling back on the sleeve to engage the hex driver into the set screw. Release the sleeve and align the tabs into the grooves on the cover plate (**Figure 29**).
- Insert the set screw into the plate and tighten to the limit of the torque handle (12 in-lb [1.355 Nm]). (**Figure 30**).

**Note:** For the Full-Plate cover plate, match the arrows on the cover plate with the arrows on the plate during insertion (**Figure 31**).

## Final Implant Position and Closure

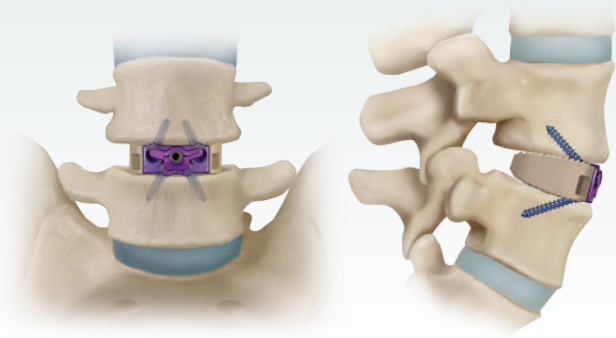

Zero-Plate

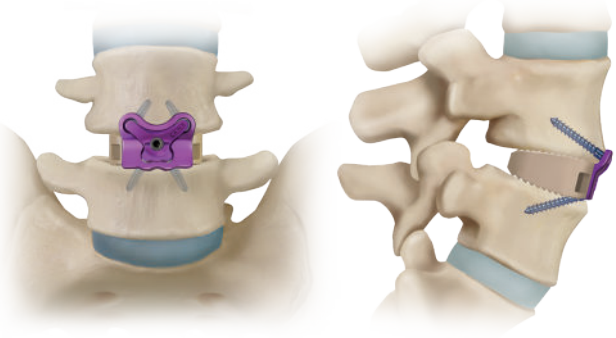

Half-Plate

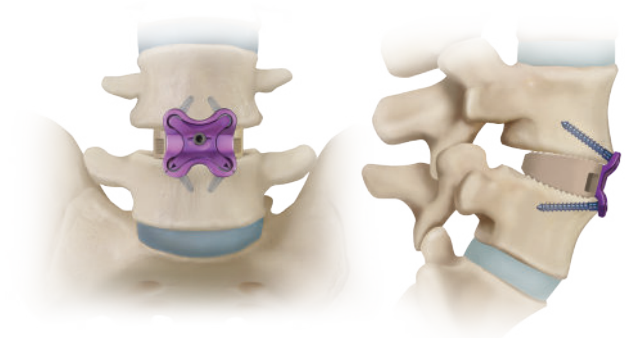

Full-Plate

### STEP 12

- Inspect final implant for correct position and assembly.

#### Removing the Durango Implant (if necessary)

- Unscrew the cover plate using the cover plate driver which is assembled on the ratcheting torque handle.
- Remove all screws using the u-joint driver solid tip or straight driver solid tip assembled to the ratcheting straight handle or ratcheting T-handle.
- Attach the universal inserter tip to the inserter handle, and insert the tip of the draw rod into the plate set screw.
- Attach the slap hammer to the inserter handle and apply upward impact until the implant is removed from the disc space.

### STEP 13

- Close the fascia and skin incision in the usual manner.

# Durango Screw Length Diagrams

## Zero-Plate

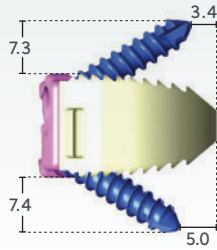

Small Spacer (24x32mm)  
20mm Screw

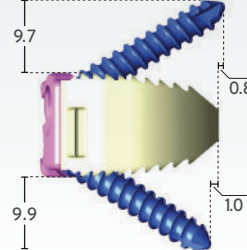
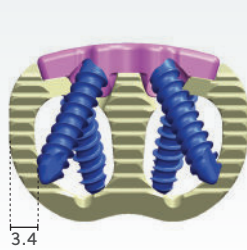

Small Spacer (24x32mm)  
25mm Screw

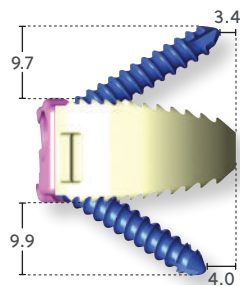
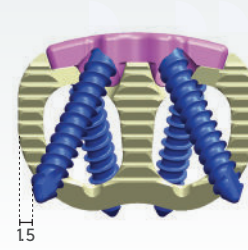

Large Spacer (27x36mm)  
25mm Screw

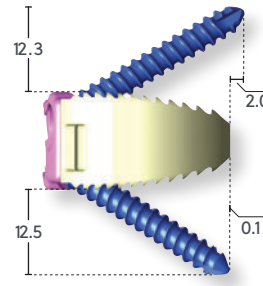
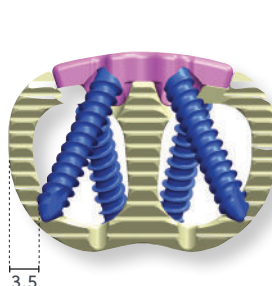

Large Spacer (27x36mm)  
30mm Screw

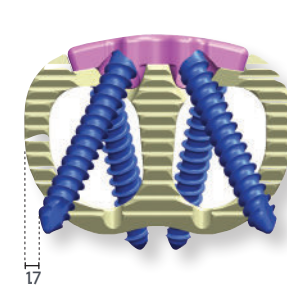

## Half-Plate

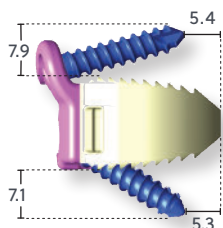

Small Spacer (24x32mm)  
20mm Screw

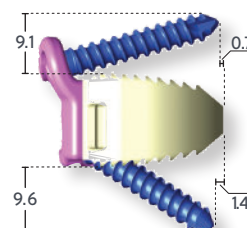
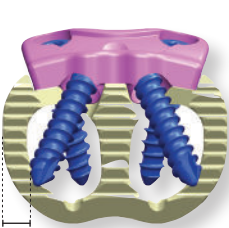

Small Spacer (24x32mm)  
25mm Screw

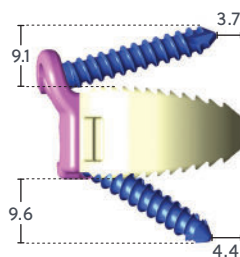
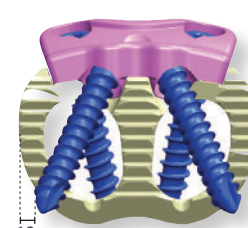

Large Spacer (27x36mm)  
25mm Screw

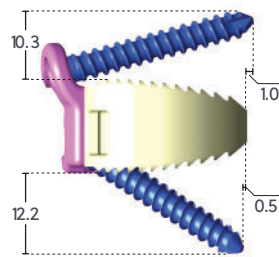
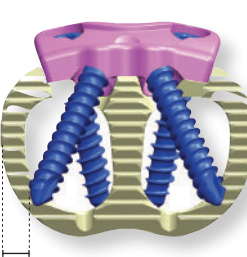

Large Spacer (27x36mm)  
30mm Screw

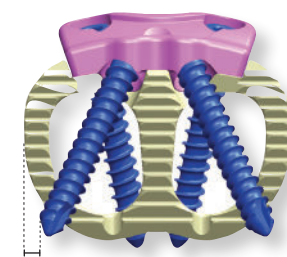



# Durango Screw Length Diagrams *(continued)*

## Full-Plate

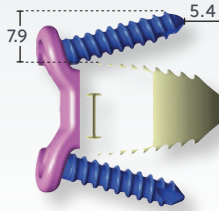

Small Spacer (24x32mm)  
20mm Screw

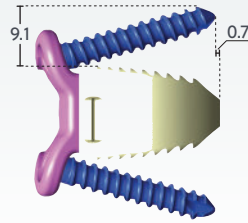
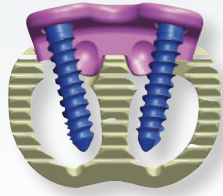

Small Spacer (24x32mm)  
25mm Screw

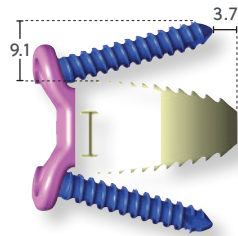
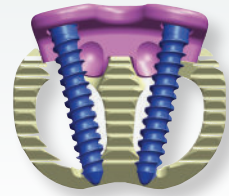

Large Spacer (27x36mm)  
25mm Screw

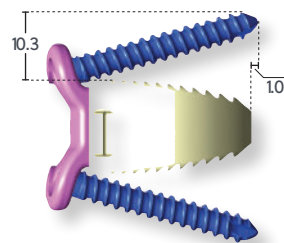
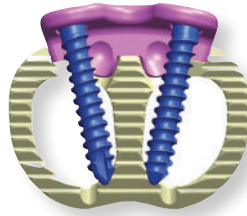

Large Spacer (27x36mm)  
30mm Screw

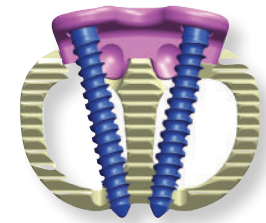

## Zero-Plate

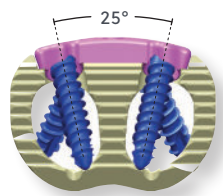
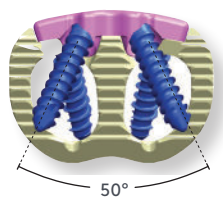
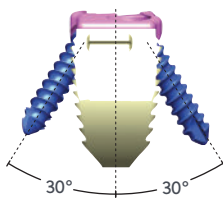

## Half-Plate

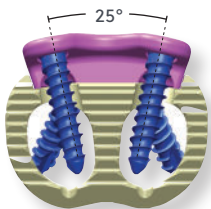
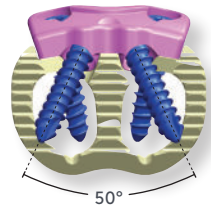
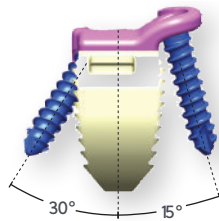

## Full-Plate

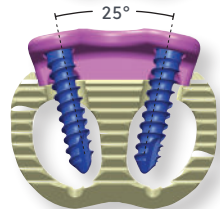
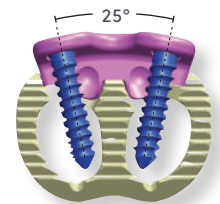
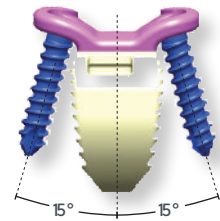



# Durango Instruments



**Inserter Handle** PART NUMBER  
8531-1000



**Universal Inserter Tip** PART NUMBER  
8531-0006



**Inserter Handle Draw Rod** PART NUMBER  
8531-0000-003



**Freehand Inserter Tip** PART NUMBER  
8531-0007



Small Trials	7° Small 24x32mm	12° Small 24x32mm
12mm	8535-0712	8535-1212
14mm	8535-0714	8535-1214
16mm	8535-0716	8535-1216
18mm	8535-0718	8535-1218



**Drill Guide A Zero-Plate** PART NUMBER  
8531-0001



Large Trials	7° Small 27x36mm	12° Small 27x36mm
12mm	8536-0712	8536-1212
14mm	8536-0714	8536-1214
16mm	8536-0716	8536-1216
18mm	8536-0718	8536-1218



**Drill Guide A Half-Plate** PART NUMBER  
8531-0002



**Drill Guide A Full-Plate** PART NUMBER  
8531-0003

## Durango Instruments (continued)



**Drill Guide B Handle** PART NUMBER  
8531-0300



**Guide B Handle Shaft** PART NUMBER  
8535-0300-001



**Guide B Handle Sleeve** PART NUMBER  
8531-0300-002



**Drill Guide B Zero-Plate** PART NUMBER  
8531-0301



**Drill Guide B Half-Plate** PART NUMBER  
8531-0302



**Drill Guide B Full-Plate** PART NUMBER  
8531-0303



**Drill Guide Adapter** PART NUMBER  
8530-1007



**Straight Drill** PART NUMBER  
8530-0102



**Straight Awl** PART NUMBER  
8530-0103



**Straight Sleeve Fixed** PART NUMBER  
8530-0403



**Straight Sleeve Variable** PART NUMBER  
8530-0400



**Straight Driver Split Tip** PART NUMBER  
8530-1104



**Straight Driver Solid Tip** PART NUMBER  
8530-1106



**Straight Driver Sleeve** PART NUMBER  
8530-0402



**Retractable Straight Driver Tip** PART NUMBER  
8530-1108



**U-Joint Drill**

PART NUMBER

8530-1002



**U-Joint Awl**

PART NUMBER

8530-1003



**U-Joint Driver Split Tip**

PART NUMBER

8530-1001



**U-Joint Driver Solid Tip**

PART NUMBER

8530-1009



**U-Joint Sleeve**

PART NUMBER

8530-1004



**Retractable Tip Variable**

PART NUMBER

8530-1005



**Retractable Tip Variable**

PART NUMBER

8530-1006



**U-Joint Driver Tip**

PART NUMBER

8530-1011



**Plate Assembly Driver**

PART NUMBER

8530-0200



**Cover Plate Driver**

PART NUMBER

8530-0300



**Ratcheting Torque Handle**

PART NUMBER

8531-0700



**Distractor/Inserter**

PART NUMBER

8800-4713



**Ratcheting Straight Handle**

PART NUMBER

9801-0003



**Ratcheting T-Handle**

PART NUMBER

9801-0011

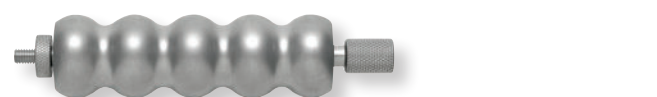

**Slap Hammer**

PART NUMBER

2200-1013

# Durango Implants



Interbody Spacers	Small 24x32mm	Large 27x36mm
12mm, 7°	8511-0712	8512-0712
14mm, 7°	8511-0714	8512-0714
16mm, 7°	8511-0716	8512-0716
18mm, 7°	8511-0718	8512-0718
12mm, 12°	8511-1212	8512-1212
14mm, 12°	8511-1214	8512-1214
16mm, 12°	8511-1216	8512-1216
18mm, 12°	8511-1218	8512-1218

Graft Volumes	Small 24x32mm	Large 27x36mm
12mm, 7°	2.68c.c.	3.84c.c.
14mm, 7°	3.15c.c.	4.57c.c.
16mm, 7°	3.62c.c.	5.26c.c.
18mm, 7°	4.10c.c.	5.95c.c.
12mm, 12°	2.54c.c.	3.68c.c.
14mm, 12°	3.01c.c.	4.37c.c.
16mm, 12°	3.48c.c.	5.06c.c.
18mm, 12°	3.96c.c.	5.75c.c.



Zero-Plate	Plate	Cover
12mm	8509-0012	8505-0012
14mm	8509-0014	8505-0014
16mm	8509-0016	8505-0016
18mm	8509-0018	8505-0018



Half-Plate	Plate	Cover
12mm	8509-0112	8505-0112
14mm	8509-0114	8505-0114
16mm	8509-0116	8505-0116
18mm	8509-0118	8505-0118



Full-Plate	Plate	Cover
12mm	8509-0212	8505-0212
14mm	8509-0214	8505-0214
16mm	8509-0216	8505-0216
18mm	8509-0218	8505-0218

## Self-Tapping Screws



Standard 4.5mm	Angle	Screw
20mm	Variable	8526-4520
25mm	Variable	8526-4525
30mm	Variable	8526-4530
20mm	Fixed	8524-4520
25mm	Fixed	8524-4525
30mm	Fixed	8524-4530



Rescue 5.0mm	Angle	Screw
20mm	Variable	8526-5020
25mm	Variable	8526-5025
30mm	Variable	8526-5030
20mm	Fixed	8524-5020
25mm	Fixed	8524-5025
30mm	Fixed	8524-5030

## Self-Drilling Screws



Standard 4.5mm	Angle	Screw
20mm	Variable	8510-4520
25mm	Variable	8510-4525
30mm	Variable	8510-4530
20mm	Fixed	8507-4520
25mm	Fixed	8507-4525
30mm	Fixed	8507-4530

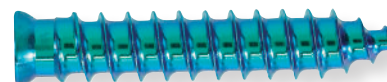

Rescue 5.0mm	Angle	Screw
20mm	Variable	8510-5020
25mm	Variable	8510-5025
30mm	Variable	8510-5030
20mm	Fixed	8507-5020
25mm	Fixed	8507-5025
30mm	Fixed	8507-5030

## Durango Marker Placement

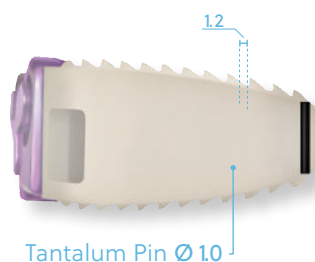
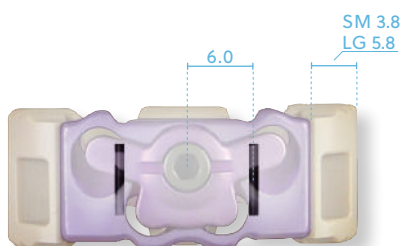
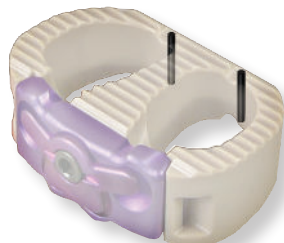

# Inspection Considerations

## Inspection Considerations

Special attention should be given to the inspection of the threads and the divots on the inserter draw rod. If damaged, return to ZimVie Spine, Inc. and use the second inserter supplied in the surgical case.

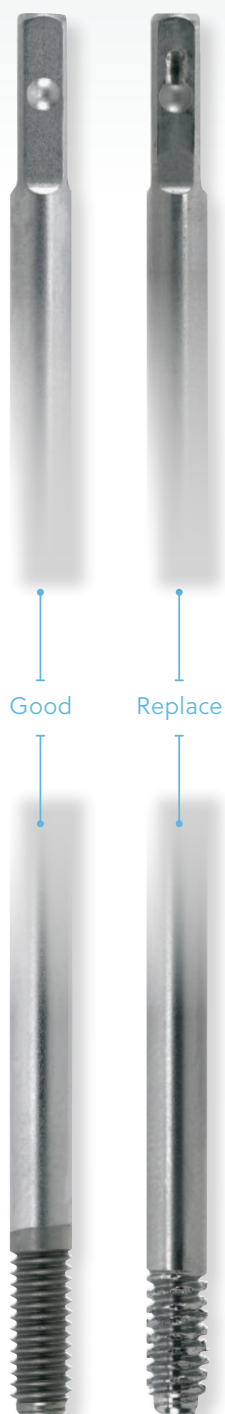

# Important Information on the Durango ALIF System

## Device Description

The Durango ALIF System is an intervertebral body fusion device consisting of a PEEK-OPTIMA® intervertebral spacer, titanium plate and screws. The interbody spacer has a generally rounded shape with various heights and footprints and has a hollowed out central area to accommodate autogenous bone graft. The upper and lower surfaces have a series of transverse grooves formed to improve stability and fixation once the device is inserted. The titanium plate has holes for receiving bone screws and a central hole for receiving a cover plate to prevent screw back-out. The Durango system is available in a variety of sizes and configurations to approximate anatomical variation in different vertebral levels and/or patient anatomy. The Durango system is provided non-sterile.

## Indications For Use

When used as a lumbar intervertebral body fusion device, the Durango system is intended for spinal fusion procedures to be used with autogenous bone graft in skeletally mature patients with degenerative disc disease (“DDD”) at one or two contiguous spinal levels from L2-S1. DDD is defined as discogenic back pain with degeneration of the disc confirmed by history and radiographic studies. These patients should have had six months of non-operative treatment. These DDD patients may have had a previous non-fusion spinal surgery at the involved spinal level(s), and may have up to Grade 1 spondylolisthesis or retrolisthesis at the involved level(s). The Durango system is to be implanted via an anterior or posterior approach and is to be combined with supplemental fixation (except as noted below). Approved supplemental fixation systems include the Biomet Spinal Fixation System. The Durango stand-alone interbody implants, when used with the integrated fixation screws, do not require use of supplemental fixation.

## Contraindications

Contraindications may be relative or absolute. The choice of a particular device must be carefully weighed against the patient’s overall evaluation. Circumstances listed below may reduce the chance of a successful outcome. Contraindications include, but are not limited to:

- Allergy to PEEK, titanium or cobalt chrome alloys, or foreign body sensitivity. Where material sensitivity is suspected, appropriate tests should be made prior to implantation.
- Known or suspected infection/immune system incompetence. Acute or chronic infectious diseases of any etiology or localization.
- Any abnormality present which affects the normal process of bone remodeling including, but not limited to, severe osteoporosis involving the spine, bone absorption, osteopenia, active infection at the site or certain metabolic disorders affecting osteogenesis.
- Morbid Obesity. An overweight or obese patient can produce loads on the spinal system, which can lead to failure of the fixation of the device or failure of the device itself.
- Any neuromuscular deficit which places an unusually heavy load on the device during the healing period.
- Open Wounds.
- Pregnancy.
- Any other medical or surgical condition which would preclude the potential benefit of spinal surgery, such as the presence of congenital abnormalities, elevation of sedimentation rate unexplained by other diseases, elevation of the white blood cell (WBC) count or a marked left shift in the WBC differential count.
- Any case requiring the mixing of components from two different systems.
- Any case requiring the mixture of stainless steel with titanium, or stainless steel with cobalt chrome implant components.
- Fever or leukocytosis.
- Signs of local infection or inflammation.
- Previous history of infection.
- Prior fusion at the level to be treated.
- Alcoholism or heavy smoking.
- Senility, mental illness or substance abuse, of a severity that the patient may ignore certain necessary limitations and precautions in the use of the implant, leading to failure or other complications.
- Any patient unwilling to follow postoperative instructions.
- Inadequate tissue coverage over the operative site.



## Possible Complications

Possible complications specific to the device may include:

- Early or late implant bending, breakage, failure, loosening or movement/migration.
- Bone fracture.
- Allergic reaction to implant material.

Other general complications associated with any spinal surgical procedure may include: Non-union or delayed union, pseudoarthrosis; pain; second surgery; bleeding; infection, early and late; tissue or nerve damage, including dural tears or other neurological problems; incisional complications; scar formation; damage to blood vessels and cardiovascular system compromise; changes in mental status; damage to internal organs and connective tissue; complications due to the use of bone grafting, including graft donor site complications; respiratory problems; reactions to anesthesia and/or death.

## Warnings

Patients with previous spinal surgery at the levels to be treated may have different clinical outcomes than previous surgical outcomes.

The risk of a device expulsion and migration is higher without the use of integrated fixation screws as indicated.

## Precautions

- The Durango implants are for single use only. Never reuse any implant even if it appears unmarked or undamaged. Reuse of the implant components may result in reduced mechanical performance, malfunction or failure of the device. Any implant implanted and then removed must be discarded. Use only new implants for each case.
- Only experienced spinal surgeons should perform the implantation of this system with specific training in the use of vertebral implants. The surgical procedure is technically demanding and presents a risk of serious injury to the patient.
- The Durango system is intended to be used only by surgeons specialized in spinal surgery and having thorough knowledge of vertebral anatomy, regional vertebral morphology and the biomechanical principles of the spine. It is advised that the surgeon also be thoroughly familiar with the surgical techniques relative to the use of the device.

- Based on fatigue testing results, the physician/surgeon must consider the levels of implantation, patient weight, patient activity level, other patient conditions, etc. which may impact on the performance of the system.
- Risks associated with neurosurgery, general surgery, orthopedic surgery and the use of general anesthesia should be explained to the patient prior to surgery. It is recommended that the advantages and disadvantages of using implants, as well as alternative treatment methods, are explained to the patient.
- Preoperatively: The surgeon must be fully conversant with all aspects of the surgical technique and know the indications and contraindications of this type of implant. The surgeon must have acquainted himself before the operation with the specific technique for insertion of the product, which is available from the manufacturer. As part of the preoperative examination, the surgeon must check that no biological, biomechanical or other factors will affect the correct conduct of the operation and the postoperative period. An appropriate range of implant sizes must be available at the time of the operation.
- Intraoperatively: The correct selection of the type and size of implant appropriate to the patient and the positioning of the implant are extremely important.
- Postoperatively: Patients must be informed of the precautions to be taken in their everyday life to guarantee a maximum implant service life. It is recommended that regular postoperative follow-up is undertaken to detect early signs of failure of the implants and to consider the action to be taken. Deterioration of the device after bone consolidation cannot be considered to constitute a dysfunction or deterioration in the characteristics of the implants. The implant can be removed after bony healing.
- Correct selection and placement of the implants is extremely important. Implant selection must be based upon the bone defect to be treated as well as the patient's weight, height, occupation or degree of physical activity.
- Proper handling of the implant before and during the operation is crucial.
- Use of the cover plate to prevent back-out of the screws is mandatory.

- If a cover plate is disassembled from a plate, it must be discarded and not reused.
- If a plate is disassembled from a PEEK-OPTIMA® interbody implant, it must be discarded and not reused.
- The Durango device must not be used with vertebral components or instruments from other manufacturers.
- Before use, inspect all instrumentation for possible damage, wear or non-function. Damaged or defective instruments should not be used or processed. Contact your local ZimVie Spine representative or dealer for repair or replacement.
- The use of an instrument for tasks other than those for which they are indicated may result in damaged or broken instruments.
- Do not apply excessive force or stress. Misuse can damage instruments or implants.
- Perform a careful preoperative review to be sure that all necessary implant components are available and that the instrument set is complete and in working order prior to initiating surgery.
- The Durango system has not been tested for safety and compatibility in the magnetic resonance (MR) environment. The Durango system has not been tested for heating or migration in the MR environment.
- Mixing of dissimilar metals can accelerate or initiate the corrosion process. Titanium components must NOT be used together in building a construct that involves other implant materials that are part of the system except where noted. Titanium and cobalt chrome may be used together within the same construct.

For more information, visit [ZimVie.com](https://www.zimvie.com)



Manufactured by:  
Zimmer Biomet Spine, Inc.  
10225 Westmoor Dr.  
Westminster, CO 80021 USA  
[ZimVie.com](https://www.zimvie.com)



Biomet 3i Dental Iberica, S.L.U  
WTC Almeda Park, Edif. 4, Planta 2  
Tirso de Molina, 40  
08940 Cornellà de Llobregat  
Barcelona, Spain  
+900 800 303



**Disclaimer:** This document is intended exclusively for physicians and is not intended for laypersons. Distribution to any other recipient is prohibited. Information on the products and procedures contained in this document is of a general nature and does not represent and does not constitute medical advice or recommendations. Because this information does not purport to constitute any diagnostic or therapeutic statement with regard to any individual medical case, each patient must be examined and advised individually, and this document does not replace the need for such examination and/or advice in whole or in part.

**Caution:** Federal (USA) law restricts this device to sale by or on the order of a physician. Rx only. Please refer to the package inserts for important product information, including, but not limited to, indications, contraindications, warnings, precautions, adverse effects, and patient counseling information.

Unless otherwise indicated, as referenced herein, all trademarks and intellectual property rights are the property of ZimVie Inc. or an affiliate; and all products are manufactured by one or more of the spinal subsidiaries of ZimVie Inc. (Zimmer Biomet Spine, Inc., Zimmer Spine, LDR Medical, etc.) and marketed and distributed by Zimmer Biomet Spine and its authorized marketing partners. PEEK-OPTIMA is a trademark of Invivio Ltd. Please refer to the Instructions for Use and the package label for the products to be used with this Surgical Technique. Product clearance and availability may be limited to certain countries/regions. This material is intended for clinicians only and does not comprise medical advice or recommendations. Distribution to any other recipient is prohibited. This material may not be copied or reprinted without the express written consent of ZimVie. 0748.3-GLBL-EN-2023.12 ©2023 ZimVie Inc. All rights reserved.



2797